

KP10 SERIES

Compact Pressure Sensor
- Switch Output

Features

- Simple installation, plug-in port or thread-in fitting
- Set pressure range :
 - 3-wire type : Vacuum (0 ~ -101.3 kPa)
 - Positive (0 ~ 0.6 MPa)
 - 2-wire type : Normally Open /
 - Normally Close (- 0.1 ~ 0.6 MPa)

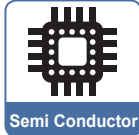
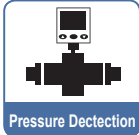
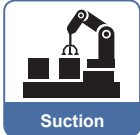

Features Highlight

1 Simple Installation

- Plug-in port for push-to-connect fittings

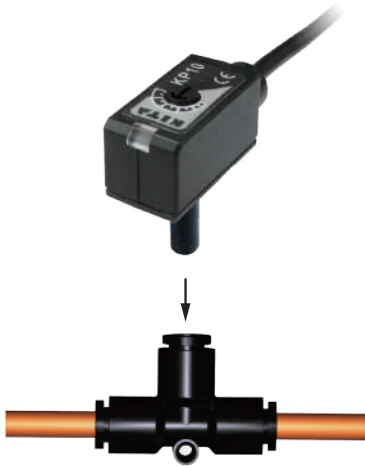

2 Compact Size

- Extremely compact size 26(L) × 10(W) × 10.4(H) mm to fit the most confined areas

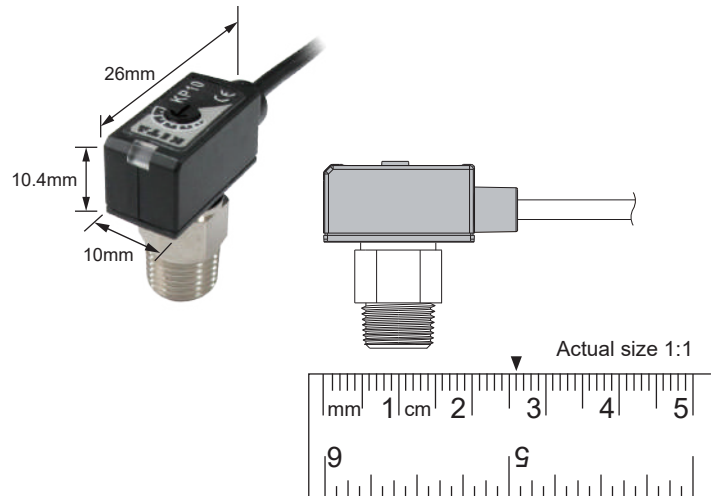

3 Space-Saving

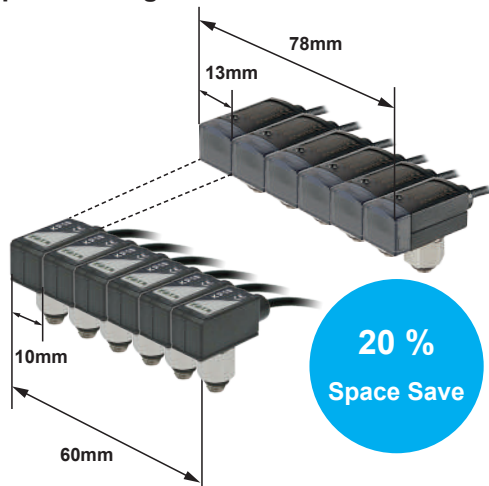

4 Sensor Installed Close to Pad



Specifications

MODEL	KP10A	KP10B	KP10V-02/04	KP10P-02/04
Set Pressure Range	- 0.1 ~ 0.6 MPa		0 ~ - 101.3 kPa	0 ~ 0.6 MPa
Withstand Pressure	1.5 MPa		0.6 MPa	1.5 MPa
Fluid	Air, Non-corrosive / Non-flammable gas			
Load Voltage	12 to 24 V DC \pm 10 %, Ripple (P-P) \leq 10 %		10.8 to 30 V DC (include ripple voltage)	
Load Current	5 ~ 40 mA		\leq 80 mA	
Leak Current	\leq 1 mA		-	
Internal Voltage Drop	\leq 5 V		NPN \leq 0.8 V, PNP \leq 0.8 V	
Current Consumption	-		\leq 10 mA	
Switch Output	Present Press. \geq Set Press. : ON	Present Press. \geq Set Press. : OFF	NPN or PNP	
Output Short Circuit Protection	No		Yes	
Setting Method	Adjusting by VR			
Repeatability	\pm 1 % F.S.			
Response Time	Approx. 1 ms			
Hysteresis	\leq 4 % F.S.		\leq 3 % F.S.	
Switch on Indicator	Indicator Red : ON			
Enclosure	IP40			
Temperature Characteristic	\pm 3 % F.S. of detected pressure (25 °C) at temp. Range of 0 ~ 50 °C			
Ambient Temp. Range	Operation : 0 ~ 60 °C (32 ~ 140 °F), Storage : -20 ~ 70 °C (-4 ~ 158 °F) (No condensation or freezing)			
Ambient Humidity Range	Operation / Storage : 35 ~ 85 % RH (No condensation)			
Vibration	Total amplitude 1.5 mm or 10 G, 10 Hz - 55 Hz - 10 Hz scan for 1 minute, two hours each direction of X, Y and Z			
Shock	980 m/s ² (100 G), 3 times each in direction of X, Y and Z			
Piping Size	R4 : \varnothing 4 mm ; R6 : \varnothing 6 mm ; F1 : R1/8", M5 ; F2 : NPT1/8", M5 ; F3 : G1/8" (BSPP), M5 ; M5 : M5 * 0.8			
Lead Wire	Oil-resistance cable, 2 / 3 wires (0.18 mm ²), \varnothing 2.6			
Weight (with 3 meter lead wire)	Approx. 50 g			

Circuit Wiring Diagram

KP10A & KP10B

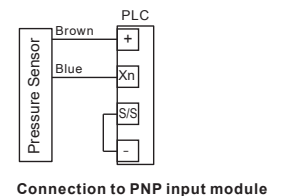
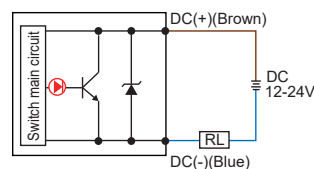
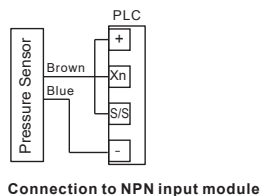
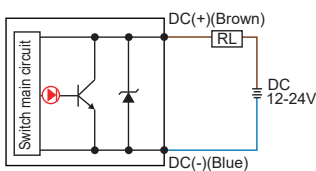

KP10□ - 02 - □ - □ NPN Output

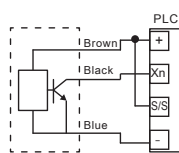
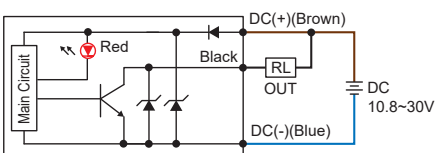

KP10□ - 04 - □ - □ PNP Output

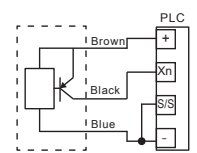
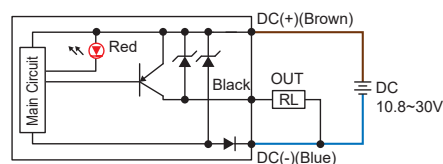

KP10 SERIES

Compact Pressure Sensor - Switch Output

Output Type

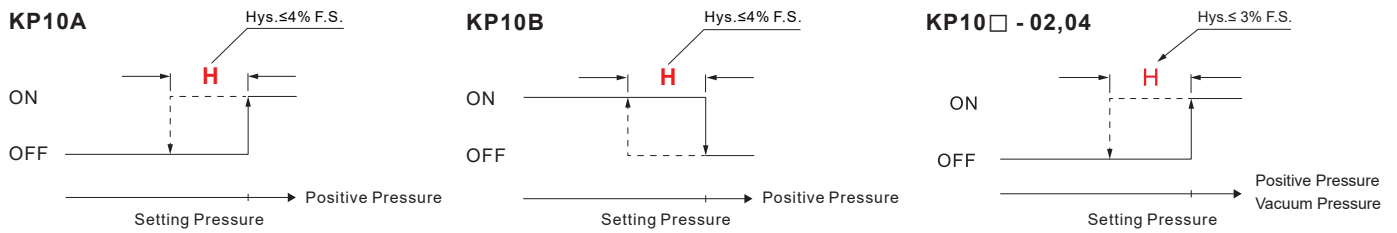

Ordering Information

K P 1 0 A - R 4 - []

Switch Specifications

- A : Switch turns ON when the pressure is larger than setting pressure. (Normally Open)
- B : Switch turns OFF when the pressure is larger than setting pressure. (Normally Close)

K P 1 0 V - 0 2 - R 4 - []

Pressure Range

- V : Vacuum (0 ~ -101.3 kPa)
- P : Positive (0 ~ 0.6 MPa)

Output Specification

- 02 : NPN output
- 04 : PNP output

Cable Length / Connector

- Blank : With 3 meter cable
- C : With M8, 3Pin male connector

Pressure Port	R4	R6	F1 / F2 / F3	M5
Appearance				
Port size	R4 : Ø4 mm	R6 : Ø6 mm	F1 : R1/8", M5 F2 : NPT1/8", M5 F3 : G1/8" (BSPP), M5	M5 : M5 * 0.8

How to Set Pressure

- Use the pressure setting trimmer to set "ON" pressure. Rotate clockwise to increase pressure setpoint. Rotate counter-clockwise to decrease pressure setpoint.
- Use appropriate size screwdriver for the setting trimmers. Gently turn the screwdriver to make adjustments. To prevent damage to the pressure setting trimmer, DO NOT force the trimmer when it comes to a stop.

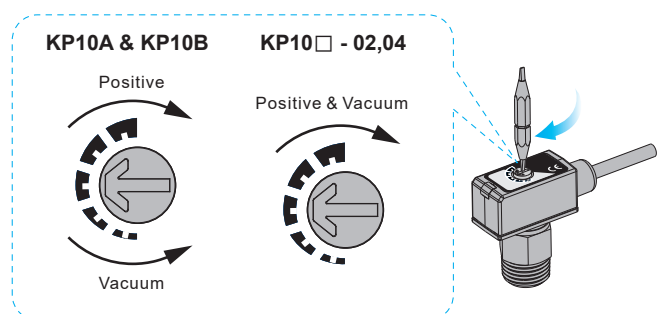

Installation Precautions

- When mounting, always use the wrench on the metallic area near the pressure port. Never apply a wrench to the plastic body, it will damage the sensor.
- Over tightening may cause damages to the port thread, mounting bracket and pressure sensor. Under tightening may result loosen or leakage.
- Apply pressure and power after installation and make necessary adjustments and inspect any possible signs of leakage to ensure proper installation.

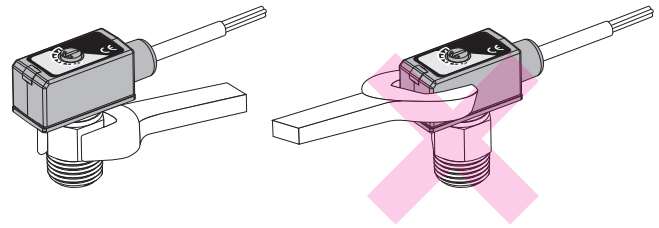

Dimensions

KP10□ - 02, 04 - □ - C

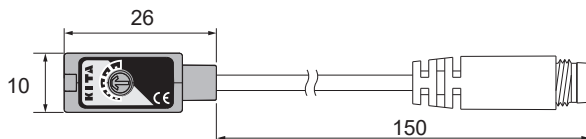

QD PINOUT

KP10A - □ - C、KP10B - □ - C

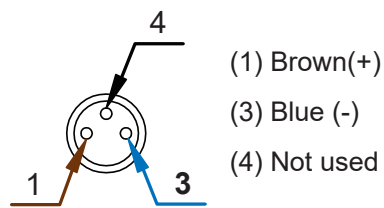

QD PINOUT

KP10□ - 02, 04 - □ - C

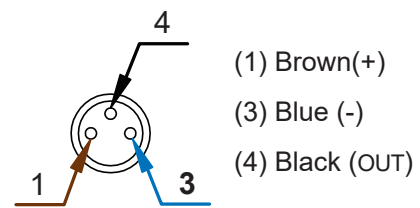

KP10□ - 02, 04 - F1, F2, F3

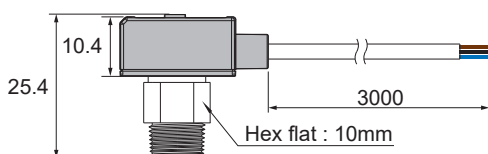

KP10□ - 02, 04 - R6

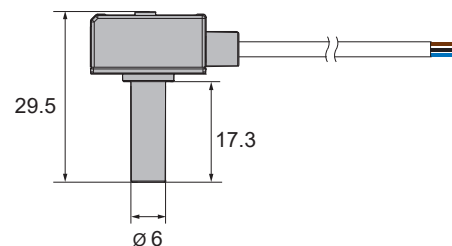

KP10□ - 02, 04 - M5

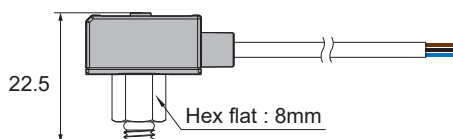

KP10□ - 02, 04 - R4

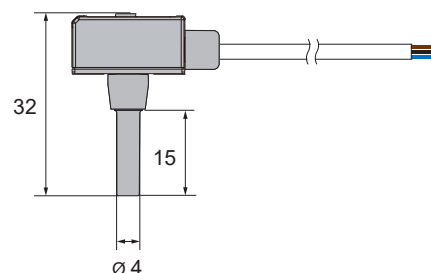

Unit : mm