

SIEMENS

Pressure transmitter

SITRANS P220 (7MF1567)

Operating Instructions

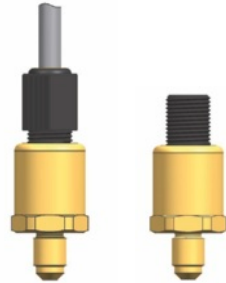

7MF1567 with plug complying with EN 175301-803-A

- Type 7MF1567-*****-1**1
- Type 7MF1567-*****-5**1

7MF1567 with plug M12x1

- Type 7MF1567-*****-2**1

7MF1567 with cable (2 m)

- Type 7MF1567-*****-3**1

7MF1567 with fast-fit cable gland

- Type 7MF1567-*****-4**1

Range of application SITRANS P220, type 7MF1567

The pressure transmitter is used to measure relative pressure and absolute pressure of gases and liquids in the following industrial sectors:

- Mechanical engineering
- Power engineering
- Water supply
- Shipbuilding
- Chemicals
- Pharmaceuticals

Device design without explosion protection

The pressure transmitter consists of a piezoresistive measuring cell with a diaphragm, installed in a stainless steel housing. It can be electrically connected using a plug complying with EN 175301-803-A (IP65), a round plug M12 (IP67), a cable (IP67) or a fast-fit cable gland (IP67). The output signal is 4 to 20 mA or 0 to 10 V.

Device design with explosion protection

The pressure transmitter consists of a piezoresistive measuring cell with a diaphragm, installed in a stainless steel housing. It can be electrically connected with a plug complying with EN 175301-803-A (IP65) or a round plug M12 (IP67). The output signal is 4 to 20 mA.

Installation

- The location of the device has no influence on the precision of the measurement.
- Before installation, compare the process data with the data of the name plate.
- The medium being measured must be suitable for the parts of the pressure transmitter in contact with the medium.
- The overload limit must not be exceeded.
- Connect the devices to a fixed cable installation.

Grounding for devices

The pressure transmitter must be connected to the equipotential bonding system of the plant via the metal housing (process connection) and the ground conductor of the plug.

Safety instructions

Symbol	Explanation of the warning symbol on the device
	Read the information in the operating instructions

In terms of a safety-instrumented system, this device left the factory in perfect condition. To maintain this status and to ensure safe operation of the device, observe the following notes:

 The device may only be used for the purposes specified in these instructions.

- When connecting up, installing and operating the device, the directives and laws of your country apply.
- Devices with the type of protection "intrinsic safety" lose their approval, if they are operated on electrical circuits that do not conform to the test certification valid for your country.
- Connect the device to a low voltage power supply with safe separation (SELV).
- The device should only be supplied with limited energy according to UL 61010-1 Second Edition, Section 9.3 or LPS in conformance with UL 60950-1 or class 2 in compliance with UL 1310 or UL 1585.
- The device can be operated both at high pressure and with aggressive and hazardous media. This means that if the device is not used properly, serious bodily injury and/or considerable damage to property cannot be excluded. This should be kept in mind particularly when the device was in use and is replaced.
- The installation, mounting and commissioning of the  devices should be performed only by trained personnel and should comply with the standards EN 60079-14 and EN 61241-14.
- The overload limit should be monitored and kept to at all times.
- The device is maintenance-free

	Direct current
--	----------------

Technical data

Mode of operation	
Measuring range $\geq 2.5 \dots \leq 600$ bar	Piezoresistive with stainless steel diaphragm

Input		
Measured variable input		
Measuring range for gauge pressure	Overload limit	Burst pressure
0 ... 2.5 bar g	$\geq -0.8 / \leq 6.25$ bar g	25 bar g
0 ... 4 bar g	$\geq -0.8 / \leq 10$ bar g	40 bar g
0 ... 6 bar g	$\geq -1 / \leq 15$ bar g	36 bar g
0 ... 10 bar g	$\geq -1 / \leq 25$ bar g	60 bar g
0 ... 16 bar g	$\geq -1 / \leq 40$ bar g	96 bar g
0 ... 25 bar g	$\geq -1 / \leq 62.5$ bar g	150 bar g
0 ... 40 bar g	$\geq -1 / \leq 100$ bar g	240 bar g
0 ... 60 bar g	$\geq -1 / \leq 150$ bar g	360 bar g
0 ... 100 bar g	$\geq -1 / \leq 250$ bar g	600 bar g
0 ... 160 bar g	$\geq -1 / \leq 400$ bar g	960 bar g
0 ... 250 bar g	$\geq -1 / \leq 625$ bar g	1 500 bar g
0 ... 400 bar g	$\geq -1 / \leq 1 000$ bar g	2 400 bar g
0 ... 600 bar g	$\geq -1 / \leq 1 500$ bar g	3 600 bar g
Measuring range for gauge pressure (for US market only)	Overload limit	Burst pressure
0 ... 30 psi g	$\geq -5.8 / \leq 80$ psi g	420 psi g
0 ... 60 psi g	$\geq -11.5 / \leq 140$ psi g	580 psi g
0 ... 100 psi g	$\geq -14.5 / \leq 300$ psi g	520 psi g
0 ... 150 psi g	$\geq -14.5 / \leq 350$ psi g	870 psi g
0 ... 200 psi g	$\geq -14.5 / \leq 550$ psi g	1 390 psi g
0 ... 300 psi g	$\geq -14.5 / \leq 800$ psi g	2 170 psi g
0 ... 500 psi g	$\geq -14.5 / \leq 1 400$ psi g	3 480 psi g
0 ... 750 psi g	$\geq -14.5 / \leq 2 000$ psi g	5 220 psi g
0 ... 1 000 psi g	$\geq -14.5 / \leq 2 000$ psi g	5 220 psi g
0 ... 1 500 psi g	$\geq -14.5 / \leq 3 500$ psi g	8 700 psi g
0 ... 2 000 psi g	$\geq -14.5 / \leq 5 500$ psi g	13 920 psi g
0 ... 3 000 psi g	$\geq -14.5 / \leq 8 000$ psi g	21 750 psi g
0 ... 5 000 psi g	$\geq -14.5 / \leq 14 000$ psi g	34 800 psi g
0 ... 6 000 psi g	$\geq -14.5 / \leq 14 000$ psi g	34 800 psi g
0 ... 8 700 psi g	$\geq -14.5 / \leq 21 000$ psi g	52 200 psi g

Output	
Current signal	4 ... 20 mA
• Burden	$(U_b - 10 \text{ V}) / 0.02 \text{ A}$
• Auxiliary power U_b	DC 7 ... 33 V --- (10 to 30 V for hazardous areas)
• Current consumption I_b	≤ 20 mA
Voltage signal	0 ... 10 VDC ---
• Burden	≥ 10 k Ω
• Auxiliary power U_b	12 ... 33 VDC ---
• Current consumption	< 7 mA at 10 k Ω
Characteristic	Linear rising

Measuring accuracy	
Measurement deviation at 25 °C (77 °F), Characteristic deviation, hysteresis and repeatability included	<ul style="list-style-type: none"> typically: 0.25 % of full scale value maximum: 0.5 % of full scale value
Setting T99	< 0.1 s
Long-term drift	
• Start-of-scale value and measuring span	0.25 % of full scale value/year
Ambient temperature influence	
• Start-of-scale value and measuring span	• 0.25 %/10 K of full-scale value
• Vibration influence (complying with IEC 60068-2-6)	0.005 %/g to 500 Hz in all directions
• Auxiliary power influence	0.005 %/V
Conditions during operation	
• Process temperature	-30 ... +120 °C (-22 to +248 °F)
• Ambient air temperature	-25 ... +85 °C (-13 to +185 °F)
– Altitude	max. 2 000 m ASL Use an appropriate power supply for altitudes higher than 2000 m ASL.
– Relative humidity	0 ... 100 %
• Storage temperature	-50 ... +100 °C (-58 to +212 °F)
• Degree of protection (complying with EN 60529)	<ul style="list-style-type: none"> IP65 with plug complying with EN 175301-803-A IP67 with M12 plug IP67 with cable IP67 with fast-fit cable gland
Electromagnetic compatibility	<ul style="list-style-type: none"> complying with EN 61326-1 complying with EN 61326-2-3 complying with NAMUR NE21, only for ATEX device and max. measured value deviation of ≤ 1 %
Construction	
Weight	approx. 0.090 kg (0.198 lb)
Process connections	Dimension drawings
Electrical connections	<ul style="list-style-type: none"> Plug complying with EN 175301-803-A Form A with cable inlet M16x1.5 or ½-14NPT or Pg 11 M12 plug 2- or 3-wire (0.5 mm²) Cable (Ø 5.4 mm) Fast-fit cable gland
Material of the parts in contact with measured material	
• Measuring cell	stainless steel , material no. 1.4016
• Process connection	stainless steel, material no. 1.4404 (SST 316 L)
Material of parts not in contact with the medium	
• Housing	stainless steel, material no. 1.4404 (SST 316 L)
• Pin and socket connector housing	<ul style="list-style-type: none"> plastic CuZn, nickel-plated (plug M12)
• Cable	• PVC spec.

Electrical connections

Connecting with current output and plug complying with EN 175301

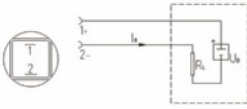

Connection 1 (+) 2 (-)

Connecting with current output and plug M12x1

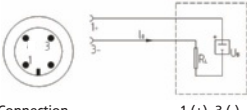

Connection 1 (+) 3 (-)

Connecting with current output and cable

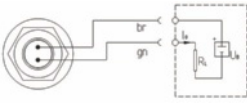

Connection br (+) gn (-)

Connecting with current output and fast-fit cable gland

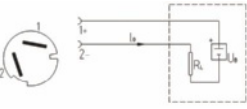

Connection 1 (+) 2 (-)

Device design with explosion protection: 4 to 20 mA

The grounding connection is conductively connected to the transmitter housing

Connecting with current output and plug complying with EN 175301 (Ex)

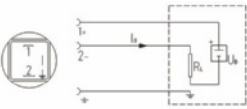

Connection 1 (+) 2 (-)

Connecting with current output and plug M12x1 (Ex)

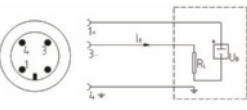

Connection 1 (+) 3 (-) 4 (⚡)

Connecting with voltage output and plug complying with EN 175301

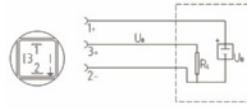

Connection 1 (+U_o) 2 (-) 3 (+U_o)

Connecting with voltage output and plug M12x1

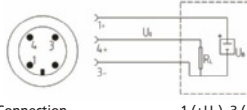

Connection 1 (+U_o) 3 (-) 4 (+U_o)

Connecting with voltage output and cable

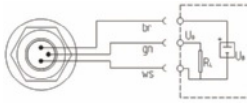

Connection br (+U_o) wt (-) gn (+U_o)

Connecting with voltage output and fast-fit cable gland

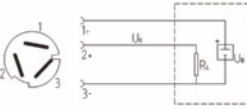

Connection 1 (+U_o) 3 (-) 2 (+U_o)

Key

I_o = output current

U_B = auxiliary power

R_L = burden

U_o = output voltage

⚡ = grounding

Correction of zero point and span



The transmitter is preset to the specific measuring range at the manufacturer's plant. An additional setting is not possible.

Maintenance

The transmitter is maintenance-free.

Check the start of scale value of the device from time to time.

Certificates and approvals	
Classification according to the pressure equipment directive (DGRL 97/23/EC)	For gases of fluid group 1 and liquids of fluid group 1; fulfills the requirements according to article 3, paragraph 3 (good engineering practice)

Protection against explosion 7MF1567-xxxx1-xxxx	
Intrinsic safety "i" (with current output only)	 II 1/2 G Ex ia IIC T4 Ga/Gb  II 1/2 D Ex ia IIC T125°C Da/Db
EC type examination certificate	SEV 10 ATEX 0146
Connection to certified intrinsically safe resistive circuits with maximum values	$U_i \leq 30 \text{ VDC}$; $I_i \leq 100 \text{ mA}$; $P_i \leq 0.75 \text{ W}$
Effective internal inductance and capacitance for versions with plugs complying with EN 175301-803-A and M12	$L_i = 0 \text{ nH}$; $C_i = 0 \text{ nF}$

Dimension drawings of the electrical connections

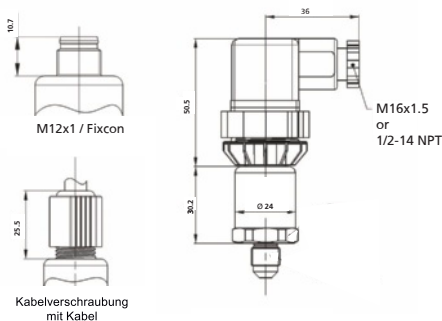

Dimension drawings of the process connections

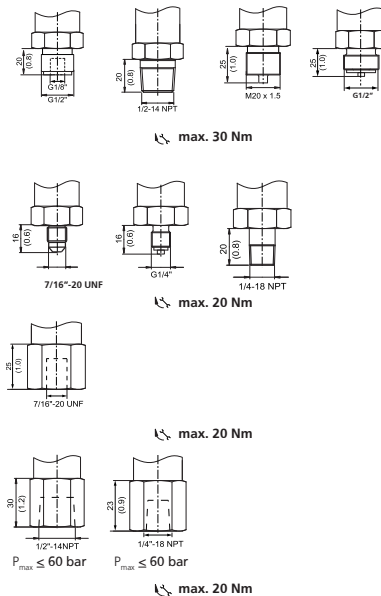

SITRANS P220, type 7MF1567

Additional notes on installation

The following conditions relating to types 7MF1567-***01-1**1 7MF1567-***01-2**1 7MF1567-***01-5**1 must be met:

Operation is permitted only when connected to certified intrinsically-safe resistive circuits with the following maximum values:

$U_i \leq 30 \text{ V}$
 $I_i \leq 100 \text{ mA}$
 $P_i \leq 750 \text{ mW}$

Internal inductance $L_i = 0 \text{ nH}$
Internal capacitance $C_i = 0 \text{ nF}$

A maximum ambient air temperature T_a of -25 to +85 °C is permitted for the pressure transmitter.

Use as a resource belonging to category 1/2:

The pressure transmitters can be mounted in the wall separating the area with category 1 requirements (zone 0) and the area with category 2 requirements (zone 1). In this case, the process connection must be adequately sealed in compliance with EN 60079-26, clause 4.6, for example by providing degree of protection IP67 in compliance with EN 60529. The supply must be via intrinsically safe circuits with type of protection ia. The measuring cell may only be used for flammable materials to which the diaphragms of the measuring cells are adequately resistant both chemically and in terms of corrosion.



The date of manufacture can be seen on the label of the pressure transmitter, for example: LKK-YMDD-XXX-XX-XXX

Manufacturer's abbreviation

Date as "year-month-day"⁽¹⁾

3 digits of the order number

Order position

Single part number

Separator

⁽¹⁾ Decoding for year, month and day information

Code ⁽²⁾	A	B	C	D	I	F	H (G) ⁽³⁾	J	K	L	M	N	P	R	S	T	U	V	W	X
Calendar year	2010	2011	2012	2013	2014	2015	2016	2017	2018	2019	2020	2021	2022	2023	2024	2025	2026	2027	2028	2029

Code ⁽²⁾	1	2	3	4	5	6	7	8	9	O	N	D
Month	January	February	March	April	May	June	July	August	September	October	November	December

Code 01 - 31
Day of month 1st to 31st day

⁽²⁾ Agreement with DIN EN 60062

⁽³⁾ The letter G is not permitted for new applications since it deviates from DIN EN 60062. It serves only for coding back.

Technical support

You can contact Technical Support for all IA and DT products:

• Via the Internet with the support request: www.siemens.com/automation/support-request

• E-mail: support.automation@siemens.com

• Phone: +49 (0) 911 895 7 222

• Fax: +49 (0) 911 895 7 223

Further information about our technical support is available on the Internet at www.siemens.com/automation/cs/service