

SIEMENS

SITRANS

Pressure transmitter SITRANS P320/P420 (mA/HART)

Compact Operating Instructions

<u>Introduction</u>	1
<u>Safety instructions</u>	2
<u>Installing/mounting</u>	3
<u>Connecting</u>	4
<u>Commissioning</u>	5
<u>Service and maintenance</u>	6
<u>Technical data</u>	7
<u>Appendix A</u>	8

7MF03.0
7MF04.0

Legal information

Warning notice system

This manual contains notices you have to observe in order to ensure your personal safety, as well as to prevent damage to property. The notices referring to your personal safety are highlighted in the manual by a safety alert symbol, notices referring only to property damage have no safety alert symbol. These notices shown below are graded according to the degree of danger.

! DANGER
indicates that death or severe personal injury will result if proper precautions are not taken.

! WARNING
indicates that death or severe personal injury may result if proper precautions are not taken.

! CAUTION
indicates that minor personal injury can result if proper precautions are not taken.

NOTICE
indicates that property damage can result if proper precautions are not taken.

If more than one degree of danger is present, the warning notice representing the highest degree of danger will be used. A notice warning of injury to persons with a safety alert symbol may also include a warning relating to property damage.

Qualified Personnel

The product/system described in this documentation may be operated only by **personnel qualified** for the specific task in accordance with the relevant documentation, in particular its warning notices and safety instructions. Qualified personnel are those who, based on their training and experience, are capable of identifying risks and avoiding potential hazards when working with these products/systems.

Proper use of Siemens products

Note the following:

! WARNING
Siemens products may only be used for the applications described in the catalog and in the relevant technical documentation. If products and components from other manufacturers are used, these must be recommended or approved by Siemens. Proper transport, storage, installation, assembly, commissioning, operation and maintenance are required to ensure that the products operate safely and without any problems. The permissible ambient conditions must be complied with. The information in the relevant documentation must be observed.

Trademarks

All names identified by ® are registered trademarks of Siemens AG. The remaining trademarks in this publication may be trademarks whose use by third parties for their own purposes could violate the rights of the owner.

Disclaimer of Liability

We have reviewed the contents of this publication to ensure consistency with the hardware and software described. Since variance cannot be precluded entirely, we cannot guarantee full consistency. However, the information in this publication is reviewed regularly and any necessary corrections are included in subsequent editions.

Table of contents

1	Introduction.....	7
1.1	Purpose of this documentation.....	7
1.2	Document history.....	7
1.3	Scope of validity of this document.....	7
1.4	Intended use.....	8
1.5	Product compatibility.....	8
1.6	Nameplate layout.....	9
1.7	Checking the consignment.....	11
1.8	Security information.....	11
1.9	Transportation and storage.....	12
1.10	Notes on warranty.....	12
2	Safety instructions.....	13
2.1	Precondition for use.....	13
2.1.1	Warning symbols on the device.....	13
2.1.2	Laws and directives.....	13
2.1.3	Conformity with European directives.....	14
2.2	Requirements for special applications.....	14
2.3	Use in hazardous areas.....	15
3	Installing/mounting.....	17
3.1	Basic safety instructions.....	17
3.1.1	Installation location requirements.....	19
3.1.1.1	Devices with marine approval.....	20
3.1.2	Proper mounting.....	20
3.2	Installation (except level).....	21
3.2.1	Installation configuration.....	21
3.2.2	Installation (except level).....	22
3.2.3	Fastening with the mounting bracket.....	22
3.3	Installation (level).....	24
3.3.1	Mounting on the container.....	25
3.4	Removing.....	28
4	Connecting.....	29
4.1	Basic safety instructions.....	29
4.2	Connecting the device.....	32
4.2.1	Opening the device.....	32
4.2.2	Connecting the device.....	33

4.2.3	Closing the device.....	34
5	Commissioning.....	37
5.1	Basic safety instructions.....	37
5.2	Switching on the supply voltage.....	38
5.3	Commissioning the device.....	39
5.4	gauge pressure, absolute pressure from the differential pressure series and absolute pressure from the gauge pressure series.....	39
5.4.1	Commissioning for gases.....	39
5.4.2	Commissioning with steam or liquid.....	41
5.5	Differential pressure and flow rate.....	42
5.5.1	Commissioning in gaseous environments.....	42
5.5.2	Commissioning for liquids.....	44
5.5.3	Commissioning with vapor.....	45
6	Service and maintenance.....	49
6.1	Basic safety instructions.....	49
6.2	Cleaning.....	50
6.2.1	Cleaning the enclosure.....	50
6.2.2	Servicing the remote seal measuring system.....	50
6.3	Maintenance and repair work.....	50
6.3.1	Defining the maintenance interval.....	51
6.3.2	Checking the gaskets.....	52
6.3.3	Diagnostics messages.....	53
6.4	Return procedure.....	53
6.5	Disposal.....	54
7	Technical data.....	55
7.1	Input.....	55
7.1.1	Gauge pressure.....	55
7.1.2	Gauge pressure with front-flush diaphragm.....	56
7.1.3	Gauge pressure from the differential pressure series.....	57
7.1.4	Absolute pressure from the gauge pressure series.....	58
7.1.5	Absolute pressure with front-flush diaphragm.....	59
7.1.6	Absolute pressure from the differential pressure series.....	60
7.1.7	Differential pressure and flow.....	61
7.1.8	Level.....	62
7.2	Measuring accuracy of SITRANS P320.....	63
7.2.1	Reference conditions.....	63
7.2.2	Effect of auxiliary power supply.....	63
7.2.3	Gauge pressure.....	63
7.2.4	Gauge pressure from the differential pressure series.....	65
7.2.5	Absolute pressure from gauge and differential pressure series.....	66
7.2.6	Absolute pressure with front-flush diaphragm.....	67
7.2.7	Gauge pressure with front-flush diaphragm.....	68
7.2.8	Differential pressure and flow.....	69
7.2.9	Level.....	72

7.3	Measuring accuracy of SITRANS P420.....	73
7.3.1	Reference conditions.....	73
7.3.2	Effect of auxiliary power supply.....	73
7.3.3	Gauge pressure.....	73
7.3.4	Gauge pressure from the differential pressure series	74
7.3.5	Absolute pressure from gauge and differential pressure series.....	76
7.3.6	Absolute pressure with front-flush diaphragm.....	77
7.3.7	Gauge pressure with front-flush diaphragm.....	78
7.3.8	Differential pressure and flow.....	78
7.3.9	Level.....	82
7.4	Operating conditions.....	83
7.5	Vibration resistance.....	87
7.6	Construction.....	89
7.7	Torques.....	93
7.8	Display, keyboard and auxiliary power.....	93
7.9	Certificates and approvals.....	94
8	Appendix A.....	97
8.1	Technical support.....	97
8.2	Certificates.....	98
	Index.....	99

Introduction

1.1 Purpose of this documentation

These instructions are a brief summary of important features, functions and safety information, and contain all information required for safe use of the device. Read the instructions carefully prior to installation and commissioning. In order to use the device correctly, first review its principle of operation.

The instructions are aimed at persons who install and commission the device.

To realize optimum performance from the device, read the complete operating instructions.

See also

Instructions and manuals (<http://www.siemens.com/processinstrumentation/documentation>)

1.2 Document history

The overview below summarizes the most important changes in the documentation when compared to the previous edition.

Edition	Note
06/2018	First edition

1.3 Scope of validity of this document

Variant	SITRANS P320 mA/HART	SITRANS P420 mA/HART
Gauge pressure	7MF0300	7MF0400
Gauge pressure from the differential pressure series	7MF0310	7MF0410
Absolute pressure from the gauge pressure series	7MF0320	7MF0420
Absolute pressure from the differential pressure series	7MF0330	7MF0430
Differential pressure and flow rate, PN 32/160 (MAWP 464/2320 psi)	7MF0340	7MF0440
Differential pressure and flow rate, PN 420 (MAWP 6092 psi)	7MF0350	7MF0450
Level	7MF0360	7MF0460

1.4 Intended use

Overview

Depending on the variant, the pressure transmitter measures corrosive, non-corrosive and hazardous gases, vapors and liquids.

You can use the pressure transmitter for the following measuring tasks:

- Gauge pressure
- Absolute pressure
- Differential pressure

With appropriate configuration and the necessary add-on parts (e.g. limiters and remote seals), the pressure transmitter can also be used for the following measuring tasks:

- Level
- Volume flow
- Mass flow
- Volume
- Customized characteristic curve

The output signal for all measuring tasks is a direct current of 4 to 20 mA.

You can install the "intrinsically-safe" or "flameproof enclosure" version of the pressure transmitter in hazardous areas. The devices have a test certification and comply with the corresponding directives.

Pressure transmitters with remote seals of various shapes can be provided for special applications. For example, measuring high-viscosity substances is a special application.

Operate the device in accordance with the specifications in section Technical data (Page 55).

1.5 Product compatibility

Edition	Comments	Product compatibility	Compatibility with device integration package
06/2018	First edition	HART FW: 1.00.08 or higher HW: 1.00.00 or higher Device version 1	SIMATIC PDM V9.0 or higher AMS Device Manager V13 or higher DTM Pactware V4.1 SP4 FC475 V3.9 or higher

1.6 Nameplate layout

Nameplate with general information

The nameplate with the article number and other important information, such as design details and technical data, is located on the cover over the buttons.

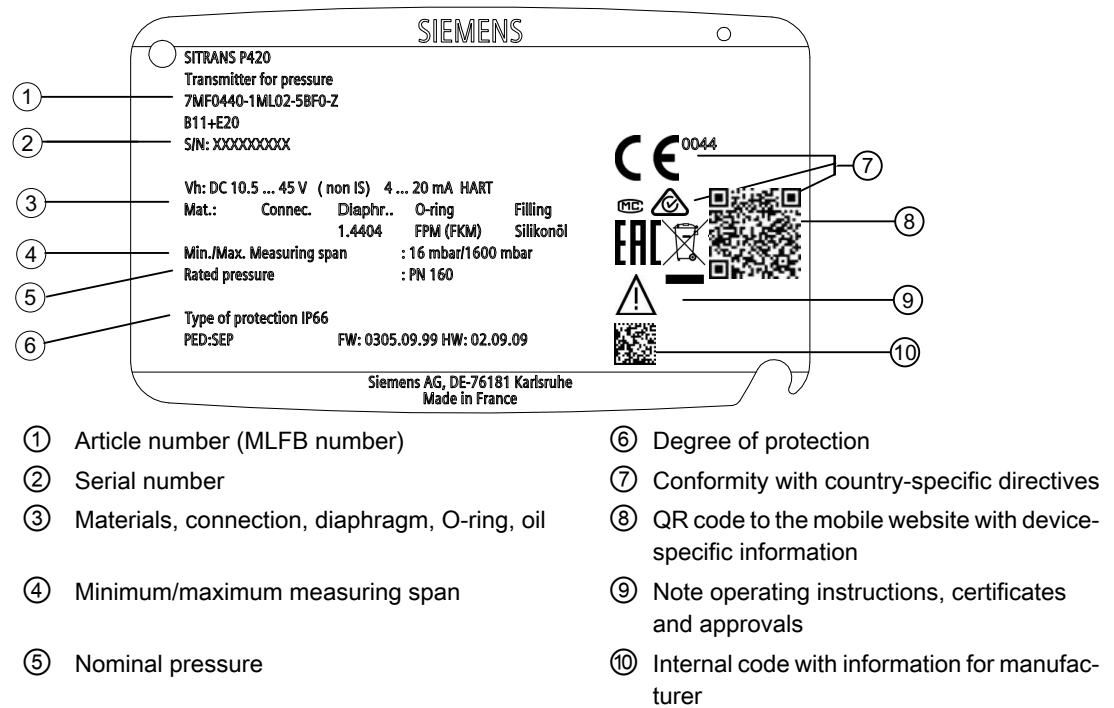
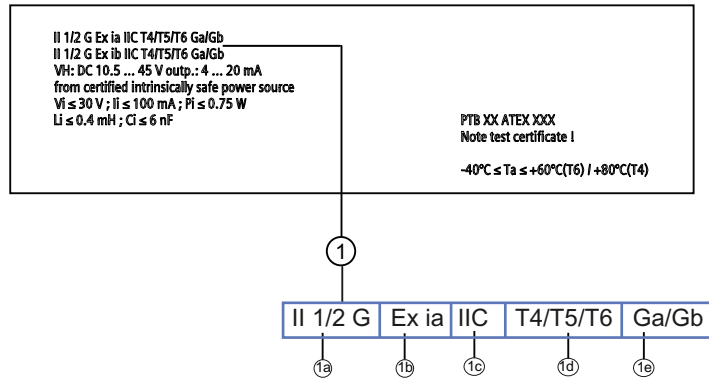

Figure 1-1 Example

Nameplate with approval information

The nameplate with approval information is located on the front of the enclosure.



- 1a Characteristics of the hazardous area
- 1b Type of protection
- 1c Group (gas, dust)
- 1d Maximum surface temperature (temperature class)
- 1e Device protection level

Figure 1-2 Example

Measuring point label

The measuring point label is fastened with a wire under the front cover.

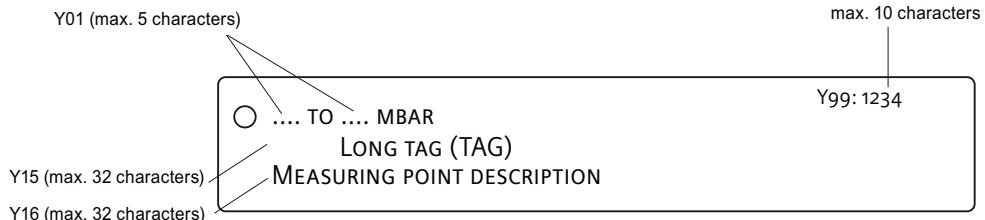

Figure 1-3 Example

Nameplate with information on the remote seals

The nameplate with information on the remote seals is located on the back of the enclosure.

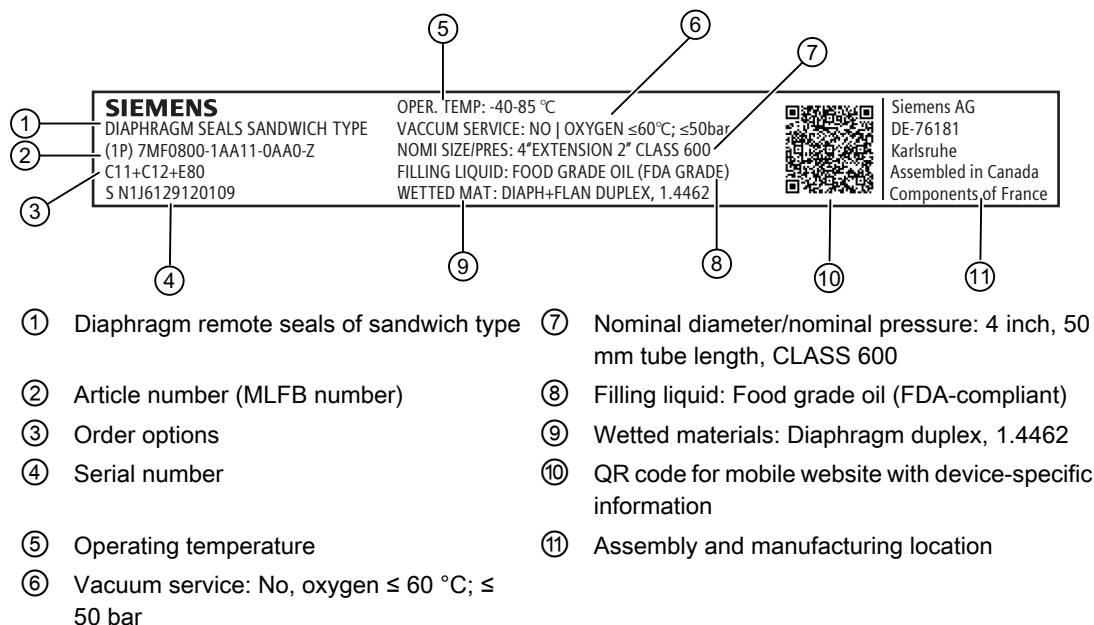



Figure 1-4 Example

1.7 Checking the consignment

1. Check the packaging and the delivered items for visible damages.
2. Report any claims for damages immediately to the shipping company.
3. Retain damaged parts for clarification.
4. Check the scope of delivery by comparing your order to the shipping documents for correctness and completeness.

 WARNING
Using a damaged or incomplete device Risk of explosion in hazardous areas. <ul style="list-style-type: none"> • Do not use damaged or incomplete devices.

1.8 Security information

Siemens provides products and solutions with industrial security functions that support the secure operation of plants, systems, machines, and networks.

In order to protect plants, systems, machines and networks against cyber threats, it is necessary to implement – and continuously maintain – a holistic, state-of-the-art industrial security concept. Siemens' products and solutions constitute one element of such a concept.

Customers are responsible for preventing unauthorized access to their plants, systems, machines and networks. Such systems, machines and components should only be connected to an enterprise network or the internet if and to the extent such a connection is necessary and only when appropriate security measures (e.g. firewalls and/or network segmentation) are in place.

For additional information on industrial security measures that may be implemented, please visit:

<https://www.siemens.com/industrialsecurity>

Siemens' products and solutions undergo continuous development to make them more secure. Siemens strongly recommends that product updates are applied as soon as they are available and that the latest product versions are used. Use of product versions that are no longer supported, and failure to apply the latest updates may increase customer's exposure to cyber threats.

To stay informed about product updates, subscribe to the Siemens Industrial Security RSS Feed under

<https://www.siemens.com/industrialsecurity>.

1.9 Transportation and storage

To guarantee sufficient protection during transport and storage, observe the following:

- Keep the original packaging for subsequent transportation.
- Devices/replacement parts should be returned in their original packaging.
- If the original packaging is no longer available, ensure that all shipments are properly packaged to provide sufficient protection during transport. Siemens cannot assume liability for any costs associated with transportation damages.

NOTICE
Insufficient protection during storage
The packaging only provides limited protection against moisture and infiltration.
<ul style="list-style-type: none">• Provide additional packaging as necessary.

Special conditions for storage and transportation of the device are listed in Technical data (Page 55).

1.10 Notes on warranty

The contents of this manual shall not become part of or modify any prior or existing agreement, commitment or legal relationship. The sales contract contains all obligations on the part of Siemens as well as the complete and solely applicable warranty conditions. Any statements regarding device versions described in the manual do not create new warranties or modify the existing warranty.

The content reflects the technical status at the time of publishing. Siemens reserves the right to make technical changes in the course of further development.

Safety instructions

2.1 Precondition for use

This device left the factory in good working condition. In order to maintain this status and to ensure safe operation of the device, observe these instructions and all the specifications relevant to safety.

Observe the information and symbols on the device. Do not remove any information or symbols from the device. Always keep the information and symbols in a completely legible state.

2.1.1 Warning symbols on the device

Symbol	Explanation
	Consult operating instructions

2.1.2 Laws and directives

Observe the safety rules, provisions and laws applicable in your country during connection, assembly and operation. These include, for example:

- National Electrical Code (NEC - NFPA 70) (USA)
- Canadian Electrical Code (CEC) (Canada)

Further provisions for hazardous area applications are for example:

- IEC 60079-14 (international)
- EN 60079-14 (EU)

2.1.3 Conformity with European directives

The CE mark on the device is a sign of conformity with the following European directives:

Electromagnetic compatibility EMC Directive of the European Parliament and of the Council on the harmonization of the laws of the Member States relating to electromagnetic compatibility 2014/30/EU	Directive of the European Parliament and of the Council on the harmonization of the laws of the Member States concerning equipment and protective systems intended for use in potentially explosive atmospheres
Atmosphère explosible ATEX 2014/34/EU	Directive of the European Parliament and of the Council on the harmonization of the laws of the Member States relating to the making available on the market of pressure equipment
Pressure Equipment Directive PED 2014/68/EU	

The directives applied can be found in the EU declaration of conformity for the associated device.

 WARNING
Improper device modifications
Risk to personnel, system and environment can result from modifications to the device, particularly in hazardous areas.
<ul style="list-style-type: none">• Only carry out modifications that are described in the instructions for the device. Failure to observe this requirement cancels the manufacturer's warranty and the product approvals.

2.2 Requirements for special applications

Due to the large number of possible applications, each detail of the described device versions for each possible scenario during commissioning, operation, maintenance or operation in systems cannot be considered in the instructions. If you need additional information not covered by these instructions, contact your local Siemens office or company representative.

Note

Operation under special ambient conditions

We highly recommend that you contact your Siemens representative or our application department before you operate the device under special ambient conditions as can be encountered in nuclear power plants or when the device is used for research and development purposes.

2.3 Use in hazardous areas

Qualified personnel for hazardous area applications

Persons who install, connect, commission, operate, and service the device in a hazardous area must have the following specific qualifications:

- They are authorized, trained or instructed in operating and maintaining devices and systems according to the safety regulations for electrical circuits, high pressures, aggressive, and hazardous media.
- They are authorized, trained, or instructed in carrying out work on electrical circuits for hazardous systems.
- They are trained or instructed in maintenance and use of appropriate safety equipment according to the pertinent safety regulations.

 WARNING
Use in hazardous area
Risk of explosion.
<ul style="list-style-type: none">• Only use equipment that is approved for use in the intended hazardous area and labelled accordingly.• Don't use devices that have been operated outside the conditions specified for hazardous areas. If you have used the device outside the conditions for hazardous areas permanently make all Ex markings unrecognizable on the nameplate.

See also

Technical data (Page 55)

 WARNING
Loss of safety of device with type of protection "Intrinsic safety Ex i"
If the device has already been operated in non-intrinsically safe circuits or the electrical specifications have not been observed, the safety of the device is no longer ensured for use in hazardous areas. There is a risk of explosion.
<ul style="list-style-type: none">• Connect the device with type of protection "Intrinsic safety" solely to an intrinsically safe circuit.• Observe the specifications for the electrical data on the certificate and/or in Technical data (Page 55).

 WARNING
Use of incorrect device parts in potentially explosive environments
Devices and their associated device parts are either approved for different types of protection or they do not have explosion protection. There is a risk of explosion if device parts (such as covers) are used for devices with explosion protection that are not expressly suited for this type of protection. If you do not adhere to these guidelines, the test certificates and the manufacturer warranty will become null and void.
<ul style="list-style-type: none">• Use only device parts that have been approved for the respective type of protection in the potentially explosive environment. Covers that are not suited for the "explosion-proof" type of protection are identified as such by a notice label attached to the inside of the cover with "Not Ex d Not SIL".• Do not swap device parts unless the manufacturer specifically ensures compatibility of these parts.

 WARNING
Incorrect material for the diaphragm in Zone 0
Risk of explosion in the hazardous area. If operated with intrinsically safe supply devices of category "ib" or devices of the flameproof enclosure version "Ex d" and simultaneous use in Zone 0, pressure transmitter explosion protection depends on the tightness of the diaphragm.
<ul style="list-style-type: none">• Ensure that the material used for the diaphragm is suitable for the process medium. Refer to the information in the section "Technical data (Page 55)".

Installing/mounting

3.1 Basic safety instructions

 DANGER
Pressure applications
Danger to personnel, system and environment will result from improper disassembly.
<ul style="list-style-type: none">• Never attempt to loosen, remove, or disassemble process connection while vessel contents are under pressure.

 WARNING
Wetted parts unsuitable for the process media
Risk of injury or damage to device.
Hot, toxic and corrosive media could be released if the process medium is unsuitable for the wetted parts.
<ul style="list-style-type: none">• Ensure that the material of the device parts wetted by the process medium is suitable for the medium. Refer to the information in Technical data (Page 55).

 WARNING
Unsuitable connecting parts
Risk of injury or poisoning.
In case of improper mounting, hot, toxic, and corrosive process media could be released at the connections.
<ul style="list-style-type: none">• Ensure that connecting parts (such as flange gaskets and bolts) are suitable for connection and process media.

 WARNING
Exceeded maximum permissible operating pressure
Risk of injury or poisoning.
The maximum permissible operating pressure depends on the device version, pressure limit and temperature rating. The device can be damaged if the operating pressure is exceeded. Hot, toxic and corrosive process media could be released.
Ensure that maximum permissible operating pressure of the device is not exceeded. Refer to the information on the nameplate and/or in Technical data (Page 55).

⚠ WARNING

Incorrect material for the diaphragm in Zone 0

Risk of explosion in the hazardous area. If operated with intrinsically safe supply devices of category "ib" or devices of the flameproof enclosure version "Ex d" and simultaneous use in Zone 0, pressure transmitter explosion protection depends on the tightness of the diaphragm.

- Ensure that the material used for the diaphragm is suitable for the process medium. Refer to the information in the section "Technical data (Page 55)".

⚠ WARNING

Loss of safety for devices with "flameproof enclosure" type of protection

Risk of explosion in hazardous areas. An explosion may be caused by hot gas escaping from the flameproof enclosure if there is too little space between it and fixed parts (e.g. walls, pipes).

- Ensure that there is a minimum clearance of at least 40 mm between the flameproof joints and the fixed parts.

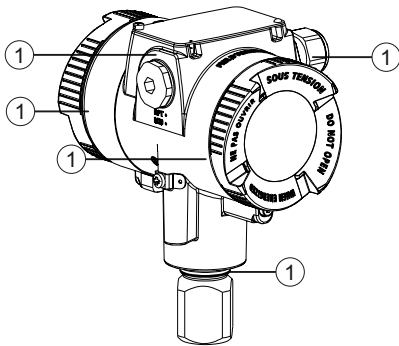

① Flameproof joint

⚠ WARNING

Vibrations in the plant

Risk of injury or damage to device.

Vibration leads to material fatigue, for example, cracks and weld seams breaks.

Hot, toxic and corrosive process media can emerge.

- Make sure that you have mounted the pressure transmitter (including accessories) protected against vibration. Refer to the information on vibration resistance in the section Technical specifications (Page 55).

 **CAUTION**

Hot surfaces resulting from hot process media

Risk of burns resulting from surface temperatures above 65 °C (149 °F).

- Take appropriate protective measures, for example contact protection.
- Make sure that protective measures do not cause the maximum permissible ambient temperature to be exceeded. Refer to the information in Technical data (Page 55).

 **CAUTION**

External stresses and loads

Damage to device by severe external stresses and loads (e.g. thermal expansion or pipe tension). Process media can be released.

- Prevent severe external stresses and loads from acting on the device.

Note

Material compatibility

Siemens can provide you with support concerning selection of sensor components wetted by process media. However, you are responsible for the selection of components. Siemens accepts no liability for faults or failures resulting from incompatible materials.

3.1.1 Installation location requirements

 **WARNING**

Insufficient air supply

The device may overheat if there is an insufficient supply of air.

- Install the device so that there is sufficient air supply in the room.
- Observe the maximum permissible ambient temperature. Refer to the information in the section Technical data (Page 55).

 **CAUTION**

Aggressive atmospheres

Damage to device through penetration of aggressive vapors.

- Ensure that the device is suitable for the application.

NOTICE
Direct sunlight Increased measuring errors. <ul style="list-style-type: none">• Protect the device from direct sunlight. Make sure that the maximum ambient temperature is not exceeded. Refer to the information in the section Technical data (Page 55).

3.1.1.1 Devices with marine approval

Note

For vibrations in the direction of the measuring cell diaphragm, the measuring accuracy of the pressure transmitter with flush-mounted diaphragm can deviate no more than 0.2% from the respective specification.

- Install the device so that no or almost no vibrations occur in the direction of the diaphragms.
- To avoid measuring values that fluctuate strongly, use the damping function.

For information on vibration resistance, refer to the marine approval certificate.

3.1.2 Proper mounting

 WARNING
Incorrect mounting at Zone 0 Risk of explosion in hazardous areas. <ul style="list-style-type: none">• Ensure sufficient tightness at the process connection.• Observe the standard IEC/EN 60079-14.

 CAUTION
Loss of type of protection Damage to device if the enclosure is open or not properly closed. The type of protection specified on the nameplate or in Technical data (Page 55) is no longer guaranteed. <ul style="list-style-type: none">• Make sure that the device is securely closed.

NOTICE

Incorrect mounting

The device can be damaged, destroyed, or its functionality impaired through improper mounting.

- Before installing ensure there is no visible damage to the device.
- Make sure that process connectors are clean, and suitable gaskets and glands are used.
- Mount the device using suitable tools. Refer to the information in Technical data (Page 55).

NOTICE

Use of line and cable entries made of plastic in hazardous areas

Device damage caused by impact at temperatures below -20 °C.

- Make sure that the line and cable entries are protected from impacts.

3.2 Installation (except level)

3.2.1 Installation configuration

The pressure transmitter can be configured above or below the pressure sampling point. The recommended configuration depends on the aggregate state of the process medium.

Installation configuration for gases

Install the pressure transmitter above the pressure sampling point.

Lay the pressure tubing with a constant gradient to the pressure sampling point, so that any condensation produced can drain in the main line and thereby avoid corruption of the measured values.

Installation configuration for vapor and liquid

Install the pressure transmitter below the pressure sampling point.

Lay the pressure tubing with a constant gradient to the pressure sampling point so that any gas pockets can escape in the main line.

3.2.2 Installation (except level)

Mounting location

Verify that the mounting location meets the following conditions:

- Accessible
- Close to the measuring point
- Vibration-free
- Within the permitted ambient temperature values

Protect the pressure transmitter from:

- Direct heat radiation
- Rapid temperature fluctuations
- Heavy contamination
- Mechanical damage
- Direct sunlight

Requirement

- You have compared the desired operating data with the data on the nameplate.
- You have adhered to the information on the remote seal during its installation.

Procedure

1. Attach the pressure transmitter to the process connection.
Use an appropriate tool (e.g. open-ended wrench with width across flats 36). Otherwise, the measuring cell may be damaged.
2. Turn only on the key area above the process connection.
Caution: If you turn the pressure transmitter on the housing, the measuring cell may be damaged.
3. To guarantee secure and vibration-free installation of the pressure transmitter, fasten it to a mounting bracket (Page 22).

3.2.3 Fastening with the mounting bracket

Introduction

You mount the pressure transmitter with the mounting bracket as described below:

- On a mounting range
- On a vertical or horizontal pipe (Ø 50 to 60 mm)

When securing, observe the torques in the section Torques (Page 93).

Note

Install the device so that the pressure transmitter and the differential pressure lines are not subject to different vibrations. Otherwise there is a danger that the differential pressure lines will rupture.

Example 1: Pipe mounting of pressure transmitter (gauge pressure series)

The mounting bracket for the gauge pressure series includes, among other things:

- 2 screws
- One pipe clamp with nuts
- Washers

Mount the pressure transmitter as follows:

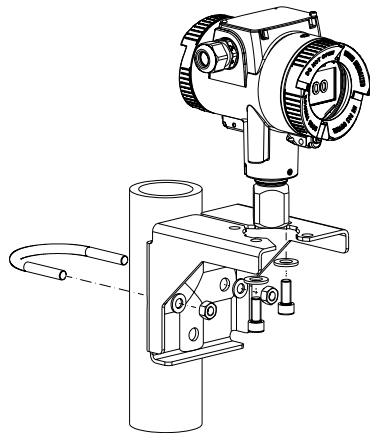

Example 2: Pipe mounting of pressure transmitter (differential pressure series)

The mounting bracket for the differential pressure series includes, among other things:

- 4 screws
- One pipe clamp with nuts
- Washers

You can then mount the pressure transmitter in different positions:

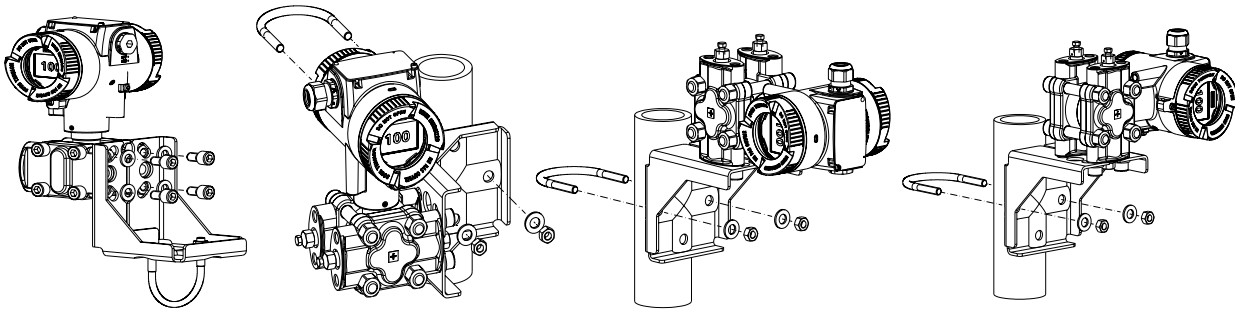

3.3 Installation (level)

Mounting location

Verify that the mounting location meets the following conditions:

- Accessible
- Close to the measuring point
- Vibration-free
- Within the permitted ambient temperature values

Protect the pressure transmitter from:

- Direct heat radiation
- Rapid temperature fluctuations
- Heavy contamination
- Mechanical damage
- Direct sunlight

Note

Select the height of the mounting flange such that the pressure transmitter is always mounted below the lowest fill height to be measured.

Requirement

- You have compared the desired operating data with the data on the nameplate.
- You have adhered to the information on the remote seal during its installation.

Procedure

To install the pressure transmitter for level, proceed as follows:

1. Attach the seal to the container's mating flange.
Ensure that the seal is centrally positioned and that it does not restrict the movement of the flange's seal diaphragm in any way. Otherwise, the seal of the process connection is not guaranteed to be tight.
2. Screw on the pressure transmitter's flange.
3. Observe the installation position.

3.3.1 Mounting on the container

Assembly on an open container

A line is not required when taking measurements in an open container since the negative side is connected with the atmosphere.

Ensure that no dirt enters the open connection ports. For example by using connection screws with a 7MF4997-1CP vent valve.

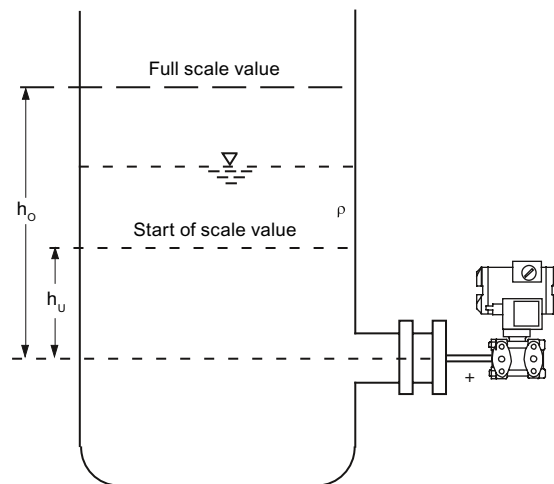

Formula:

$$\text{Start of scale value: } p_{MA} = \rho \cdot g \cdot h_U$$

$$\text{Full-scale value: } p_{ME} = \rho \cdot g \cdot h_O$$

Measurement assembly on an open container

h_U Lower filling level
 h_O Upper filling level
 ρ Pressure

Δp_{MA} Start of scale value
 Δp_{ME} Full-scale value
 ρ Density of the measured medium in the container
 g Acceleration due to gravity

Assembly on a closed container

When taking measurements in a closed container without or with little condensate formation, the negative pressure line is not filled. Lay the line in such a way that condensation pockets do not form. Install a condensation container if required.

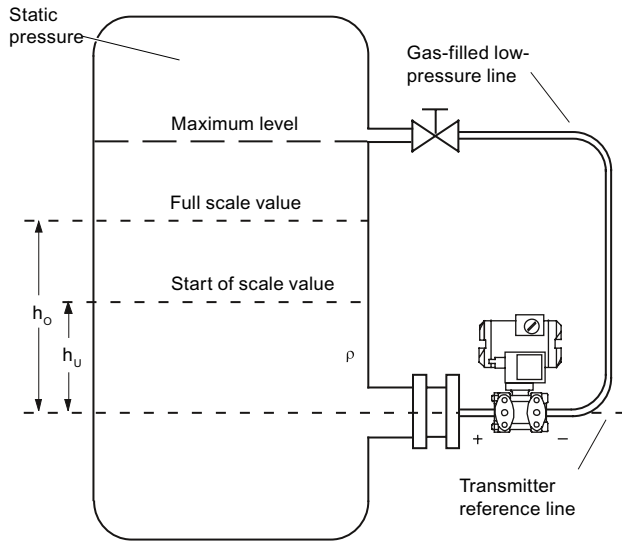

Formula:

Start of scale value: $\Delta p_{MA} = \rho \cdot g \cdot h_U$

Full-scale value: $\Delta p_{ME} = \rho \cdot g \cdot h_O$

Measurement assembly on a closed container (no or little condensate separation)

- h_U Lower filling level
- h_O Upper filling level
- ρ Pressure

- Δp_{MA} Start of scale value
- Δp_{ME} Full-scale value
- ρ Density of the measured medium in the container
- g Acceleration due to gravity

When taking measurements in a closed container with strong condensate formation, you must fill the negative pressure line (mostly with the condensate of the measured medium) and install a condensate pot. Lock the device using the dual pneumatic block 7MF9017-..A.

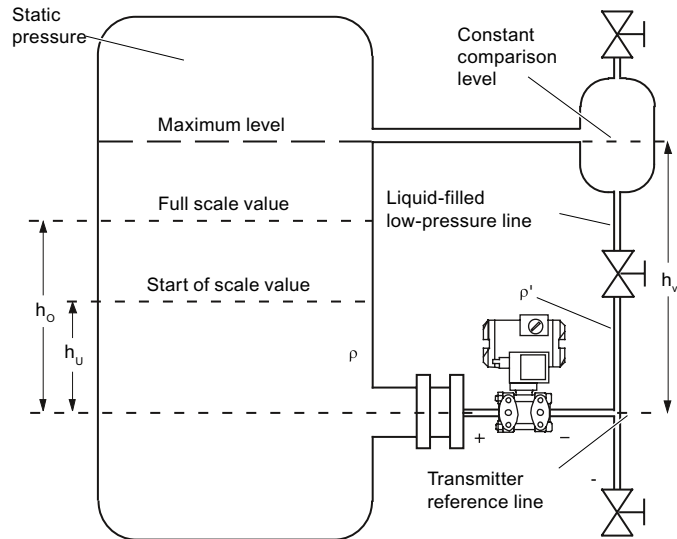

Formula:

Start of scale value:

$$\Delta p_{MA} = g \cdot (h_U \cdot \rho - h_V \cdot \rho')$$

Full-scale value:

$$\Delta p_{MA} = g \cdot (h_O \cdot \rho - h_V \cdot \rho')$$

Measurement assembly on a closed container (strong condensate formation)

h_U	Lower filling level	Δp_{MA}	Start of scale value
h_O	Upper filling level	Δp_{ME}	Full-scale value
h_V	Gland distance	ρ	Density of the measured medium in the container
p	Pressure	ρ'	Density of fluid in the negative pressure line corresponds to the prevailing temperature there
		g	Acceleration due to gravity

The process connection on the negative side is a female thread $1/4$ -18 NPT or an oval flange.

Lay the line for the negative pressure using a seamless steel tube 12 mm x 1.5 mm.

3.4 Removing

<p> WARNING</p> <p>Incorrect disassembly</p> <p>The following risks may result from incorrect disassembly:</p> <ul style="list-style-type: none">- Injury through electric shock- Risk through emerging media when connected to the process- Risk of explosion in hazardous area <p>In order to disassemble correctly, observe the following:</p> <ul style="list-style-type: none">● Before starting work, make sure that you have switched off all physical variables such as pressure, temperature, electricity etc. or that they have a harmless value.● If the device contains hazardous media, it must be emptied prior to disassembly. Make sure that no environmentally hazardous media are released.● Secure the remaining connections so that no damage can result if the process is started unintentionally.
--

Connecting

4.1 Basic safety instructions

 WARNING
Unsuitable cables, cable glands and/or plugs
Risk of explosion in hazardous areas.
<ul style="list-style-type: none">• Use only cable glands/plugs that comply with the requirements for the relevant type of protection.• Tighten the cable glands in accordance with the torques specified in Technical data (Page 55).• Close unused cable inlets for the electrical connections.• When replacing cable, glands use only cable glands of the same type.• After installation, check that the cables are seated firmly.

 WARNING
Incorrect conduit system
Risk of explosion in hazardous areas as result of open cable inlet or incorrect conduit system.
<ul style="list-style-type: none">• In the case of a conduit system, mount a spark barrier at a defined distance from the device input. Observe national regulations and the requirements stated in the relevant approvals.

 WARNING
Lack of equipotential bonding
Risk of explosion through compensating currents or ignition currents through lack of equipotential bonding.
<ul style="list-style-type: none">• Ensure that the device is potentially equalized.
Exception: It may be permissible to omit connection of the equipotential bonding for devices with type of protection "Intrinsic safety Ex i".

 WARNING
Unprotected cable ends
Risk of explosion through unprotected cable ends in hazardous areas.
<ul style="list-style-type: none">• Protect unused cable ends in accordance with IEC/EN 60079-14.

 WARNING
Improper laying of shielded cables
Risk of explosion through compensating currents between hazardous area and the non-hazardous area.
<ul style="list-style-type: none">• Shielded cables that cross into hazardous areas should be grounded only at one end.• If grounding is required at both ends, use an equipotential bonding conductor.

 WARNING
Connecting device in energized state
Risk of explosion in hazardous areas.
<ul style="list-style-type: none">• Connect devices in hazardous areas only in a de-energized state.
Exceptions:
<ul style="list-style-type: none">• Devices having the type of protection "Intrinsic safety Ex i" may also be connected in energized state in hazardous areas.• Exceptions for type of protection "Increased safety ec" (Zone 2) are regulated in the relevant certificate.

 WARNING
Incorrect selection of type of protection
Risk of explosion in areas subject to explosion hazard.
This device is approved for several types of protection.
<ol style="list-style-type: none">1. Decide in favor of one type of protection.2. Connect the device in accordance with the selected type of protection.3. In order to avoid incorrect use at a later point, make the types of protection that are not used permanently unrecognizable on the nameplate.

NOTICE
Ambient temperature too high
Damage to cable sheath.
<ul style="list-style-type: none">• At an ambient temperature ≥ 60 °C (140 °F), use heat-resistant cables suitable for an ambient temperature at least 20 °C (36 °F) higher.

NOTICE**Condensation in the device**

Damage to device through formation of condensation if the temperature difference between transportation or storage and the mounting location exceeds 20 °C (36 °F).

- Before taking the device into operation let the device adapt for several hours in the new environment.

NOTICE**Incorrect measured values with incorrect grounding**

The device must not be grounded using the "+" connection. It may otherwise malfunction and be permanently damaged.

- If necessary, ground the device using the "-" connection.

Note**Electromagnetic compatibility (EMC)**

You can use this device in industrial environments, households and small businesses.

For metal housings there is an increased electromagnetic compatibility compared to high-frequency radiation. This protection can be increased by grounding the housing, see Technical data (Page 55).

Note**Improvement of interference immunity**

- Lay signal cables separate from cables with voltages > 60 V.
 - Use cables with twisted wires.
 - Keep device and cables at a distance from strong electromagnetic fields.
 - Take account of the conditions for communication specified in the Technical data (Page 55).
 - Use shielded cables to guarantee the full specification according to HART/PA/FF.
-

4.2 Connecting the device

4.2.1 Opening the device

Procedure

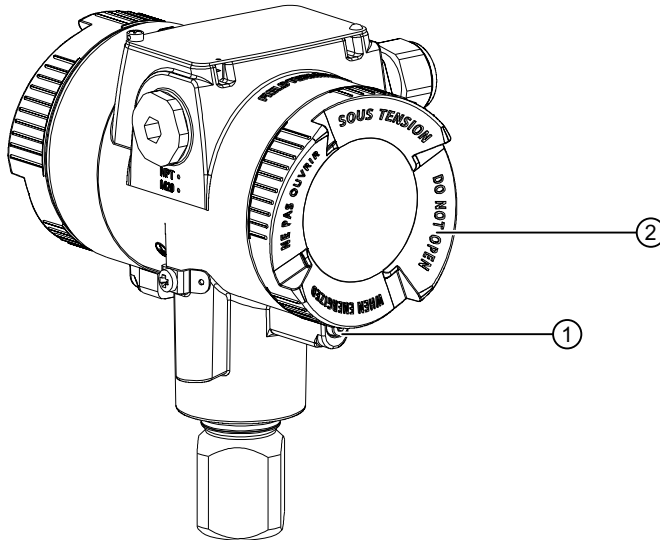

- ① Safety catch (optional)
- ② Cover of the electrical cable compartment.

Figure 4-1 Rear view of pressure transmitter

1. Use a 3 mm Allen key to loosen the safety catch ①.
2. Unscrew the cover of the electrical cable compartment ②.

4.2.2 Connecting the device

Procedure

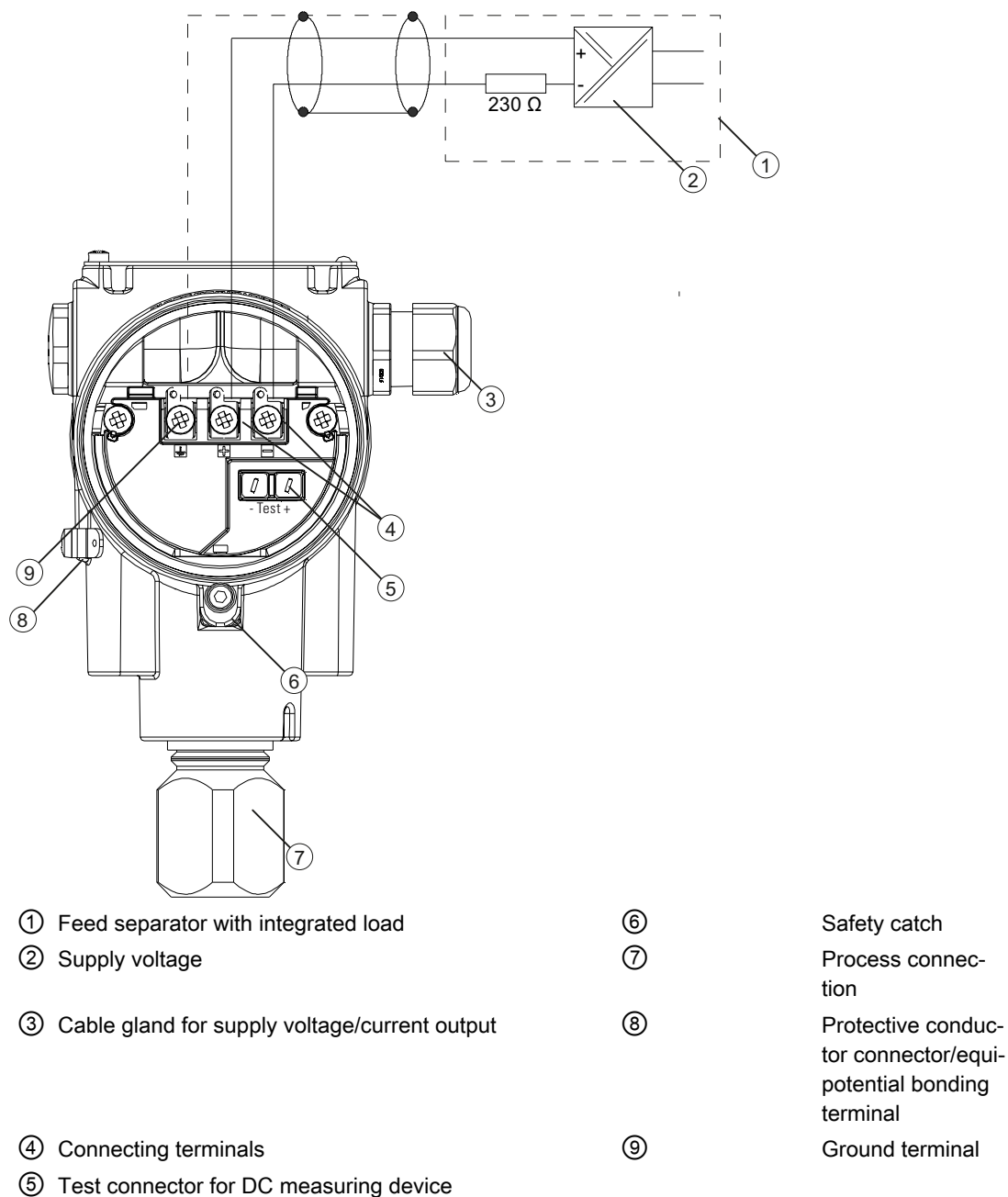

Figure 4-2 Example: Electrical connection with feed separator

1. Lead the connecting cable through the cable gland ③.
2. Connect the device to the plant using the existing protective conductor connection ⑧.

4.2 Connecting the device

3. Connect the wires to the connecting terminals ④ "+" and "-".
Ensure the correct polarity!
4. Apply the shield to the screw of the ground terminal ⑨.
The screw of the ground terminal is electrically connected to the external protective conductor connection.

NOTICE

Incorrect measured values with incorrect grounding

The device must not be grounded using the "+" connection. It may otherwise malfunction and be permanently damaged.

- If necessary, ground the device using the "-" connection.

4.2.3 Closing the device

Procedure

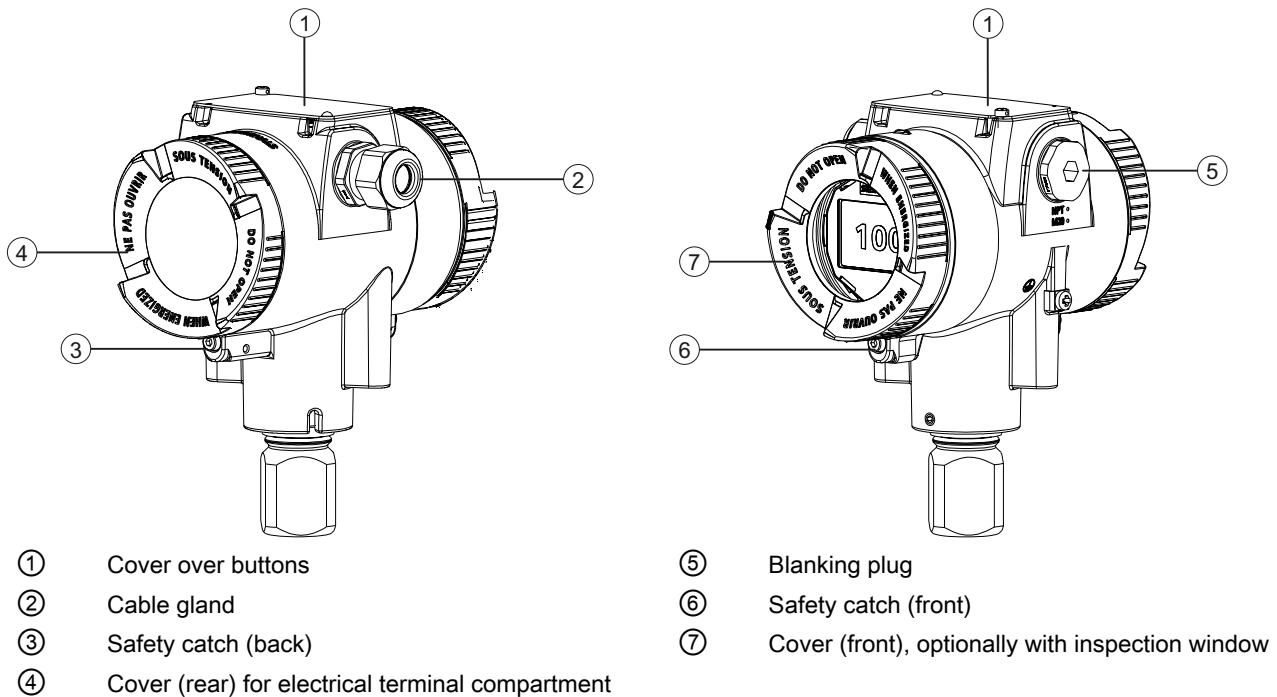

Figure 4-3 View of the pressure transmitter: Left: Back right: Front view

1. Screw on the cover ④ and ⑦ as far as it will go.
Make sure that there is no gap between enclosure and cover.
2. Secure each cover with the cover catch ③ and ⑥ by removing the screw.
3. Close the cover over the buttons ①.

4. Tighten the screw for the cover over the buttons.
5. Check the tightness of the blanking plug ⑤ and cable gland ② in accordance with the degree of protection.

5.1 Basic safety instructions

DANGER

Toxic gases and liquids

Danger of poisoning when venting the device: if toxic process media are measured, toxic gases and liquids can be released.

- Before venting ensure that there are no toxic gases or liquids in the device, or take the appropriate safety measures.

WARNING

Improper commissioning in hazardous areas

Device failure or risk of explosion in hazardous areas.

- Do not commission the device until it has been mounted completely and connected in accordance with the information in Technical data (Page 55).
- Before commissioning take the effect on other devices in the system into account.

WARNING

Commissioning and operation with pending error

If an error message appears, correct operation in the process is no longer guaranteed.

- Check the gravity of the error.
- Correct the error.
- If the error still exists:
 - Take the device out of operation.
 - Prevent renewed commissioning.

WARNING

Loss of explosion protection

Risk of explosion in hazardous areas if the device is open or not properly closed.

- Close the device as described in Connecting (Page 29).

 WARNING
Opening device in energized state
Risk of explosion in hazardous areas
<ul style="list-style-type: none">• Only open the device in a de-energized state.• Check prior to commissioning that the cover, cover locks, and cable inlets are assembled in accordance with the directives.
Exception: Devices having the type of protection "Intrinsic safety Ex i" may also be opened in energized state in hazardous areas.

 WARNING
Hazardous contact voltage
Risk of injury through hazardous contact voltage when the device is open or not completely closed.
The degree of protection specified on the nameplate or in Technical data (Page 55) is no longer guaranteed if the device is open or not properly closed.
<ul style="list-style-type: none">• Make sure that the device is securely closed.

Note

Hot surfaces

Hot process medium and high ambient temperatures lead to hot surfaces which can cause burns.

- Take corresponding protective measures, for example wear protective gloves.
-

5.2 Switching on the supply voltage

Requirement

- You have connected the device correctly. (Page 32)
- The terminal voltage on the device is correct. (Page 93)

5.4 gauge pressure, absolute pressure from the differential pressure series and absolute pressure from the gauge pressure series

Procedure

Switch on the power supply.

- Product name and firmware version appear briefly on the display.
- The measured values are shown on the display.
For a device without a display, you read off the current output as follows:
 - Over the remote control (e.g. SIMATIC PDM).
 - With a DC current measuring device.
Connecting the device (Page 33)

Result

The device is now ready for operation.

5.3 Commissioning the device

Ensure that the operating data matches the values specified on the nameplate.

The parameters for damping, characteristic curve, start of scale value/full scale value and fault current must agree with the settings of the measuring point.

You can find more detailed information on operation and configuration in the operating instructions.

The following commissioning cases are typical examples. Configurations different from those listed here may be useful depending on the system configuration.

5.4 gauge pressure, absolute pressure from the differential pressure series and absolute pressure from the gauge pressure series

5.4.1 Commissioning for gases

Requirement

All valves are closed.

Procedure

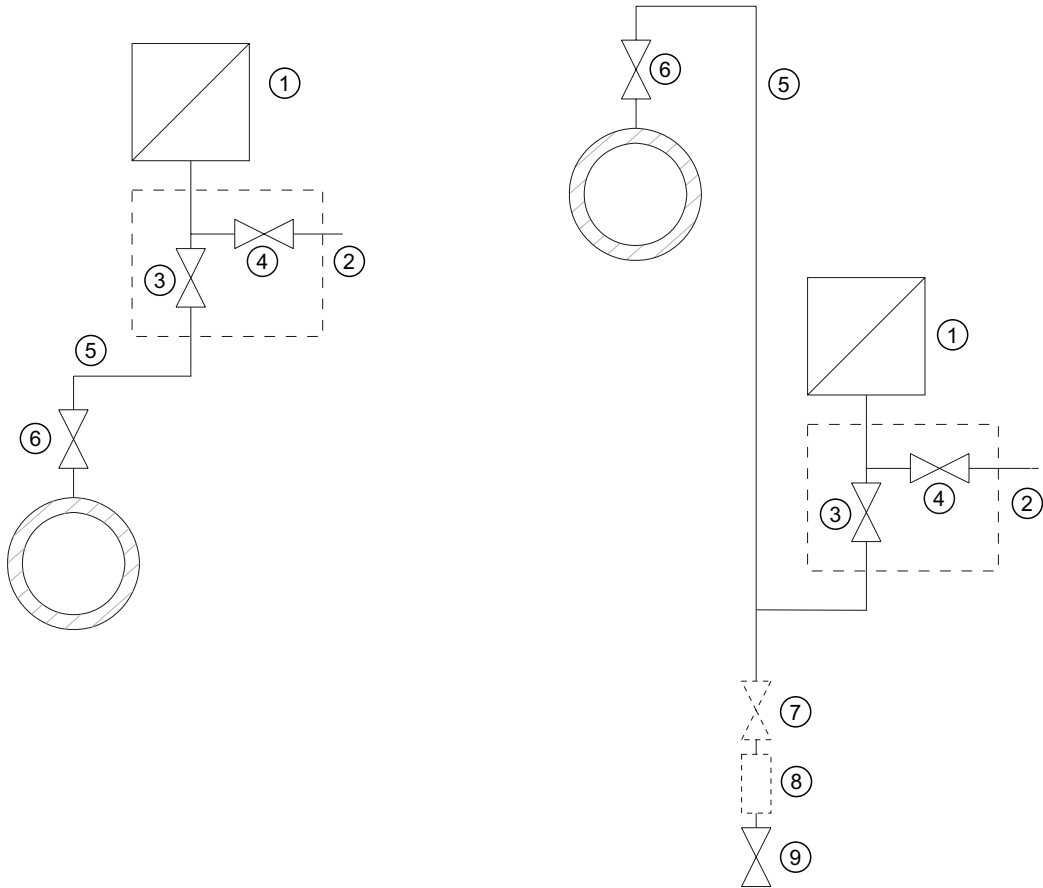

Example: Measuring gases above the pressure tapping point

Example: Measuring gases below the pressure tapping point

- | | |
|---|--------------------------------|
| ① Pressure transmitter | ⑤ Pressure line |
| ② Shut-off valve | ⑥ Shut-off valve |
| ③ Shut-off valve to process | ⑦ Shut-off valve (optional) |
| ④ Shut-off valve for test connection or for bleed screw | ⑧ Condensate vessel (optional) |
| | ⑨ Blowout valve |

To commission the pressure transmitter for gases, proceed as follows:

1. Open the shut-off valve for the test connection ④.
2. Via the test connection of the shut-off valve ②, apply the pressure corresponding to the start of scale value to the pressure transmitter.
3. Ensure that the lower range value corresponds to the desired value. Otherwise, correct the value.
4. Close the shut-off valve for the test connection ④.

5.4 gauge pressure, absolute pressure from the differential pressure series and absolute pressure from the gauge pressure series

5. Open the shut-off valve ⑥ at the pressure tapping point.
6. Open the shut-off valve for the process ③.

5.4.2 Commissioning with steam or liquid

Requirement

All valves are closed.

Procedure

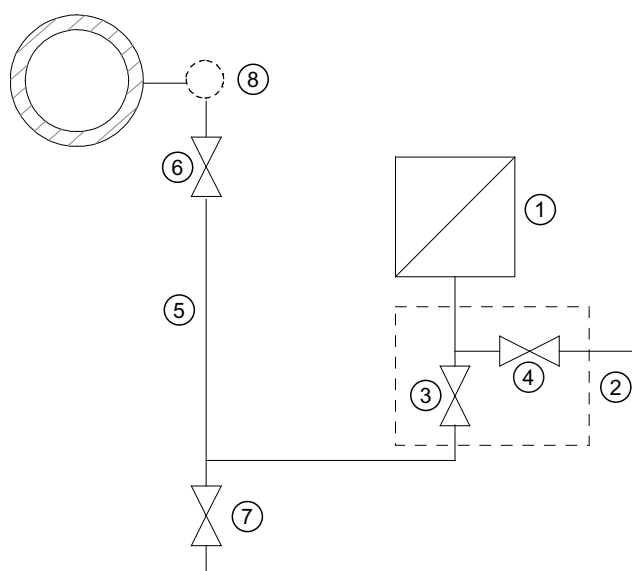

- ① Pressure transmitter
- ② Shut-off valve
- ③ Shut-off valve to process
- ④ Shut-off valve for test connection or for bleed screw
- ⑤ Pressure line
- ⑥ Shut-off valve
- ⑦ Drain valve
- ⑧ Compensation vessel (steam only)

To commission the pressure transmitter for steam or liquid, proceed as follows:

1. Open the shut-off valve for the test connection ④.
2. Via the test connection of the shut-off valve ②, apply the pressure corresponding to the start of scale value to the pressure transmitter.
3. Ensure that the lower range value corresponds to the desired value. Otherwise, correct the value.
4. Close the shut-off valve for the test connection ④.

5. Open the shut-off valve ⑥ at the pressure tapping point.
6. Open the shut-off valve for the process ③.

5.5 Differential pressure and flow rate

 **WARNING**

Incorrect or improper operation

If the lock screws are missing or are not sufficiently tight, and/or if the valves are operated incorrectly or improperly, it could lead to serious physical injuries or considerable damage to property.

Measure

- Make sure that the lock screws and/or the vent valve are screwed in and fully tightened.
- Operate the valves properly.

5.5.1 Commissioning in gaseous environments

Requirement

All shut-off valves are closed.

Procedure

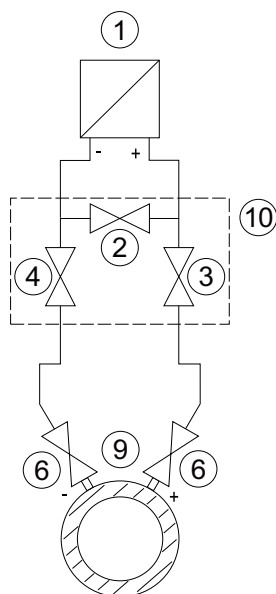

Pressure transmitter above the differential pressure transducer

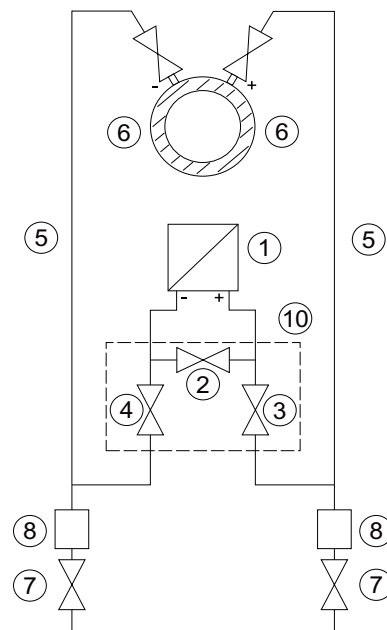

Pressure transmitter below the differential pressure transducer

- | | | | |
|------|------------------------------|---|----------------------------------|
| ① | Pressure transmitter | ⑦ | Blowout valves |
| ② | Stabilizing valve | ⑧ | Condensate vessels (optional) |
| ③, ④ | Differential pressure valves | ⑨ | Differential pressure transducer |
| ⑤ | Differential pressure lines | ⑩ | 3-way valve manifold |
| ⑥ | Shut-off valves | | |

To commission the pressure transmitter for gases, proceed as follows:

1. Open both the shut-off valves ⑥ at the pressure tapping point.
2. Open the stabilizing valve ②.
3. Open the differential pressure valve (③ or ④).
4. Check and, if necessary, correct the zero point when the start-of-scale value is 0 bar (4 mA).
5. Close the stabilizing valve ②.
6. Open the other differential pressure valve (③ or ④).

5.5.2 Commissioning for liquids

Requirement

All valves are closed.

! DANGER

Toxic liquids

Danger of poisoning when the device is vented.

If toxic process media are measured with this device, toxic liquids can escape when the device is vented.

- Before venting, make sure there is no liquid in the device or take the necessary safety precautions.

Procedure

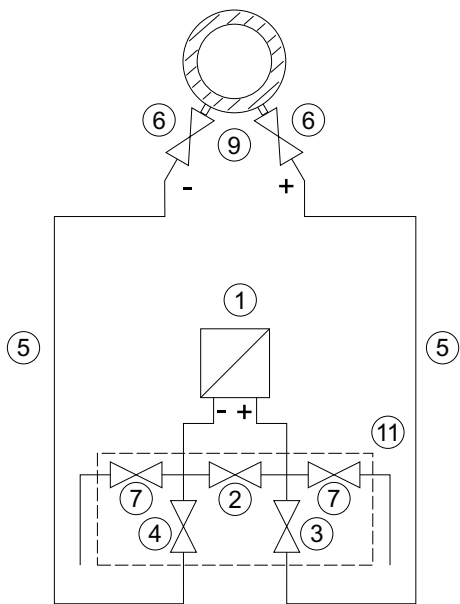

Pressure transmitter below the differential pressure transducer

- ① Pressure transmitter
- ② Stabilizing valve
- ③, ④ Differential pressure valves
- ⑤ Differential pressure lines
- ⑥ Shut-off valves

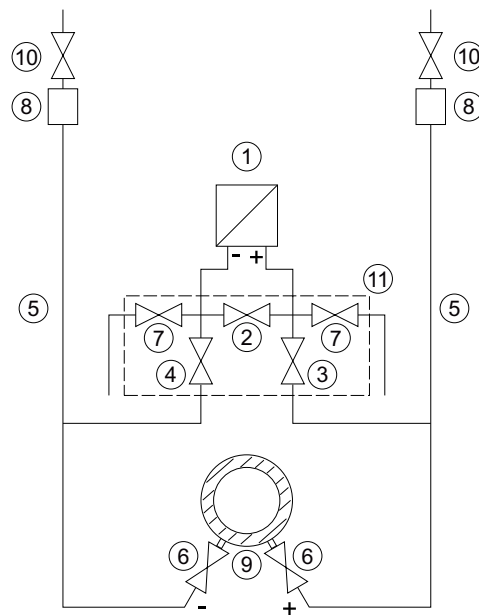

Pressure transmitter above the differential pressure transducer

- ⑦ Drain valves
- ⑧ Gas collector vessels (optional)
- ⑨ Differential pressure transducer
- ⑩ Vent valves
- ⑪ 5-way valve manifold

To commission the pressure transmitter for liquids, proceed as follows:

1. Open both the shut-off valves ⑥ at the pressure tapping point.
2. Open the stabilizing valve ②.
3. With **pressure transmitters below the differential pressure transducer**, partially open both drain valves ⑦ one after the other until liquid emerges without bubbles.
In the case of a **pressure transmitter above the differential pressure transducer**, partially open both vent valves ⑩ one after the other until liquid emerges without bubbles.
4. Close both drain valves ⑦ or vent valves ⑩.
5. Partially open the differential pressure valve ③ and the vent valve (sealing plug with vent valve) on the positive side of the pressure transmitter until liquid escapes without bubbles.
6. Close the vent valve (sealing plug with vent valve).
7. Partially open the vent valve (sealing plug with vent valve) on the negative side of the pressure transmitter until liquid escapes without bubbles.
8. Close the differential pressure valve ③.
9. Partially open the differential pressure valve ④ until liquid escapes without bubbles.
10. Close the differential pressure valve.
11. Close the vent valve (sealing plug with vent valve) on the negative side of the pressure transmitter.
12. Open the differential pressure valve ③ with half a revolution.
13. For a lower range value of 0 bar, check the zero point (4 mA) and correct the lower range value if it is different.
14. Close the stabilizing valve ②.
15. Open the differential pressure valves (③ and ④) completely.

5.5.3 Commissioning with vapor

Requirement

All valves are closed.

 WARNING
<p>Hot vapor</p> <p>Danger of injury or damage to device.</p> <p>If the shut-off valves ⑥ and the differential pressure valve ③ are both open and the stabilizing valve ② is then opened, the pressure transmitter ① can be damaged by the flow of vapor.</p> <ul style="list-style-type: none"> • Follow the specified procedure for commissioning.

<p>! WARNING</p> <p>Hot vapor</p> <p>Danger of injury.</p> <p>You can briefly open the drain valves ⑦ to clean the line. Hot vapor can escape in the process.</p> <ul style="list-style-type: none"> • Only open the drain valves ⑦ briefly, and close them again before vapor escapes.
--

Procedure

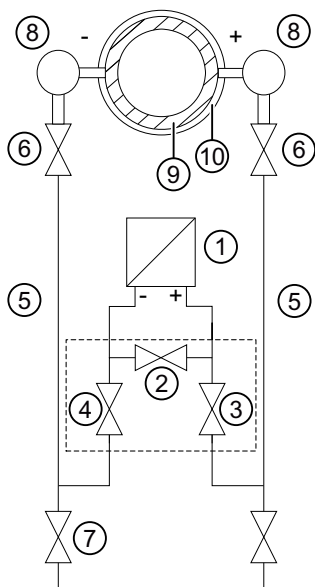

- | | |
|---------------------------------|--|
| ① Pressure transmitter | ⑦ Drain valves |
| ② Stabilizing valve | ⑧ Condensate pots |
| ③, Differential pressure valves | ⑨ Differential pressure transducer/Orifice plate |
| ④ | |
| ⑤ Differential pressure lines | ⑩ Insulation |
| ⑥ Shut-off valves | ⑪ 3-way valve manifold |

To commission the pressure transmitter for vapor, proceed as follows:

1. Open both the shut-off valves ⑥ at the pressure tapping point.
2. Open the stabilizing valve ②.
3. Wait until the steam in the differential pressure lines ⑤ and in the equalizing vessels ⑧ has condensed.
4. Partially open the differential pressure valve ③ and the vent valve (sealing plug with vent valve) on the positive side of the pressure transmitter until condensate escapes without bubbles.
5. Close the vent valve (sealing plug with vent valve).

6. Partially open the vent valve (sealing plug with vent valve) on the negative side of the pressure transmitter until condensate escapes without bubbles.
7. Close the differential pressure valve ③.
8. Partially open the differential pressure valve ④ until condensate escapes without bubbles.
9. Close the vent valve with blanking plug on the negative side ①.
10. Close the differential pressure valve.
11. Open the differential pressure valve ③ by half a revolution.
12. For the start of scale value 0 bar, check the zero point (4 mA).
If the differential pressure lines ⑤ have equally high condensate columns with the same temperature, the measurement result is error-free. Otherwise, repeat the zero-point adjustment.
13. Close the stabilizing valve ②.
14. Fully open the differential pressure valves ③ and ④.

Cleaning process cable

1. To clean the line, briefly open the drain valves ⑦.
2. Close the drain valve ⑦ before vapor escapes.

Service and maintenance

6.1 Basic safety instructions

 WARNING
Use of a computer in a hazardous area If the interface to the computer is used in the hazardous area, there is a risk of explosion. <ul style="list-style-type: none">• Ensure that the atmosphere is explosion-free (hot work permit).

 WARNING
Dust layers above 5 mm Risk of explosion in hazardous areas. Device may overheat due to dust build up. <ul style="list-style-type: none">• Remove dust layers in excess of 5 mm.

 CAUTION
Releasing button lock Improper modification of parameters could influence process safety. <ul style="list-style-type: none">• Make sure that only authorized personnel may cancel the button locking of devices for safety-related applications.

NOTICE
Penetration of moisture into the device Device damage. <ul style="list-style-type: none">• Make sure when carrying out cleaning and maintenance work that no moisture penetrates the inside of the device.

6.2 Cleaning

6.2.1 Cleaning the enclosure

Cleaning the enclosure

- Clean the outside of the enclosure with the inscriptions and the display window using a cloth moistened with water or a mild detergent.
- Do not use any aggressive cleansing agents or solvents, e.g. acetone. Plastic parts or the painted surface could be damaged. The inscriptions could become unreadable.

 **WARNING**

Electrostatic charge

Risk of explosion in hazardous areas if electrostatic charges develop, for example, when cleaning plastic surfaces with a dry cloth.

- Prevent electrostatic charging in hazardous areas.

NOTICE

Improper cleaning of diaphragm

Device damage. The diaphragm can be damaged.

- Do not use sharp or hard objects to clean the diaphragm.

6.2.2 Servicing the remote seal measuring system

The remote seal measuring system usually does not need servicing.

If the mediums are contaminated, viscous or crystallized, it could be necessary to clean the diaphragm from time to time. Use only a suitable solvent to remove the deposits from the diaphragm. Do not use corrosive cleaning agents. Prevent the diaphragm from getting damaged due to sharp-edged tools.

6.3 Maintenance and repair work

 **WARNING**

Impermissible repair and maintenance of the device

- Repair and maintenance must be carried out by Siemens authorized personnel only.

 WARNING
Impermissible repair of explosion protected devices
Risk of explosion in hazardous areas
<ul style="list-style-type: none">• Repair must be carried out by Siemens authorized personnel only.

 CAUTION
Hot surfaces
Risk of burns during maintenance work on parts having surface temperatures exceeding 70 °C (158 °F).
<ul style="list-style-type: none">• Take corresponding protective measures, for example by wearing protective gloves.• After carrying out maintenance, remount touch protection measures.

6.3.1 Defining the maintenance interval

 WARNING
No maintenance interval has been defined
Device failure, device damage, and risk of injury.
<ul style="list-style-type: none">• Define a maintenance interval for recurring tests depending on the use of the device and your own experience.• The maintenance interval will vary from site to site depending on corrosion resistance.

 WARNING
Maintenance during continued operation in a hazardous area
There is a risk of explosion when carrying out repairs and maintenance on the device in a hazardous area.
<ul style="list-style-type: none">• Isolate the device from power.
- or -
<ul style="list-style-type: none">• Ensure that the atmosphere is explosion-free (hot work permit).

 WARNING
Impermissible accessories and spare parts
Risk of explosion in areas subject to explosion hazard.
<ul style="list-style-type: none">• Only use original accessories or original spare parts.• Observe all relevant installation and safety instructions described in the instructions for the device or enclosed with the accessory or spare part.

 WARNING
Hot, toxic or corrosive process media
Risk of injury during maintenance work.
When working on the process connection, hot, toxic or corrosive process media could be released.
<ul style="list-style-type: none">• As long as the device is under pressure, do not loosen process connections and do not remove any parts that are pressurized.• Before opening or removing the device ensure that process media cannot be released.

 WARNING
Improper connection after maintenance
Risk of explosion in areas subject to explosion hazard.
<ul style="list-style-type: none">• Connect the device correctly after maintenance.• Close the device after maintenance work.
Refer to Connecting the device (Page 32).

6.3.2 Checking the gaskets

Inspect the seals at regular intervals

Note
Incorrect seal changes
Incorrect measured values will be displayed. Changing the seals in a process flange of a differential pressure measuring cell can alter the start-of-scale value.
<ul style="list-style-type: none">• Changing seals in devices with differential pressure measuring cells may only be carried out by personnel authorized by Siemens.

Note**Using the wrong seals**

Using the wrong seals with flush-mounted process connections can cause measuring errors and/or damage the diaphragm.

- Always use seals which comply with the process connection standards or are recommended by Siemens.
-

1. Clean the enclosure and seals.
2. Check the enclosure and seals for cracks and damage.
3. Grease the seals, if necessary, or replace the seals.

6.3.3 Diagnostics messages

Diagnostics (e.g. sensor break) detected by the internal self-test are signaled as follows:

- Display: NE107 symbol and diagnostics ID
- Current output (4-20 mA): Fault current
- HART: Diagnostic alarm via the remote operation

In the event of a defect, you can replace the transmitter electronics with observation of the warning notes and the operating instructions.

6.4 Return procedure

Enclose the bill of lading, return document and decontamination certificate in a clear plastic pouch and attach it firmly to the outside of the packaging. Any devices/replacement parts which are returned without a decontamination declaration will be cleaned at your expense before further processing. For further details, refer to the operating instructions.

See also

Decontamination declaration (<http://www.siemens.com/sc/declarationofdecontamination>)

Return document (<http://www.siemens.com/processinstrumentation/returngoodsnote>)

6.5 Disposal



Devices described in this manual should be recycled. They may not be disposed of in the municipal waste disposal services according to the Directive 2012/19/EC on waste electronic and electrical equipment (WEEE).

Devices can be returned to the supplier within the EC, or to a locally approved disposal service for eco-friendly recycling. Observe the specific regulations valid in your country.

Further information about devices containing batteries can be found at: Information on battery/product return (WEEE) (<https://support.industry.siemens.com/cs/document/109479891/>)

Note

Special disposal required

The device includes components that require special disposal.

- Dispose of the device properly and environmentally through a local waste disposal contractor.
-

Technical data

7.1 Input

7.1.1 Gauge pressure

Gauge pressure input			
Measured variable	Gauge pressure		
Measuring span (continuously adjustable) or measuring range, max. operating pressure (in accordance with 2014/68/EU Pressure Equipment Directive) and max. test pressure (in accordance with DIN 16086) (for oxygen measurement, max. 100 bar and 60 °C ambient temperature/process temperature)	Measuring span	Maximum permissible operating pressure MAWP (PS)	Maximum test pressure
	8.3 ... 250 mbar	4 bar	6 bar
	0.83 ... 25 kPa	0.4 MPa	0.6 MPa
	0.12 ... 3.6 psi	58 psi	87 psi
	0.01 ... 1 bar	6 bar	9 bar
	1 ... 100 kPa	0.6 MPa	0.9 MPa
	0.15 ... 14.5 psi	87 psi	130 psi
	0.04 ... 4 bar	20 bar	30 bar
	4 ... 400 kPa	2 MPa	3 MPa
	0.58 ... 58 psi	290 psi	435 psi
	0.16 ... 16 bar	45 bar	70 bar
	0.016 ... 1.6 MPa	4.5 MPa	7 MPa
	2.3 ... 232 psi	652 psi	1015 psi
	0.63 ... 63 bar	80 bar	120 bar
	0.063 ... 6.3 MPa	8 MPa	12 MPa
	9.1 ... 914 psi	1160 psi	1740 psi
	1.6 ... 160 bar	240 bar	360 bar
	0.16 ... 16 MPa	24 MPa	36 MPa
	23 ... 2321 psi	3480 psi	5221 psi
	4 ... 400 bar	400 bar	600 bar
	0.4 ... 40 MPa	40 MPa	60 MPa
	58 ... 5802 psi	5802 psi	8702 psi
	7 ... 700 bar	800 bar	800 bar
	0.7 ... 70 MPa	80 MPa	80 MPa
	102 ... 10153 psi	11603 psi	11603 psi

Gauge pressure measuring limits	
Lower measuring limit ¹⁾	
• Measuring cell with silicone oil filling	30 mbar a/3 kPa a/0.44 psi a

7.1 Input

Gauge pressure measuring limits	
• Measuring cell with inert oil	30 mbar a/3 kPa a/0.44 psi a
• Measuring cell with FDA-compliant oil	100 mbar a/10 kPa a/1.45 psi a
Upper measuring limit	100% of max. range (for oxygen measurement: max. 100 bar/10 MPa/1450 psi and 60 °C ambient temperature/medium temperature)
Start of scale value	Between the measuring limits (continuously adjustable)

¹⁾ For 250 mbar/25 kPa/3.6 psi measuring cells, the low measuring limit is 750 mbar a/75 kPa a/10.8 psi a. The measuring cell is vacuum-tight down to 30 mbar a/3 kPa a/0.44 psi a.

7.1.2 Gauge pressure with front-flush diaphragm

Gauge pressure input with front-flush diaphragm			
Measured variable	Gauge pressure		
Measuring span (continuously adjustable) or measuring range, max. operating pressure and max. test pressure	Measuring span	Maximum permissible operating pressure MAWP (PS)	Maximum test pressure
	0.01 ... 1 bar	Refer to the information on the nameplate of the pressure transmitter and the data on the mounting flange ¹⁾	
	1 ... 100 kPa		
	0.15 ... 14.5 psi		
	0.04 ... 4 bar		
	4 ... 400 kPa		
	0.58 ... 58 psi		
	0.16 ... 16 bar		
	0.016 ... 1.6 MPa		
	2.3 ... 232 psi		
0.6 ... 63 bar			
0.063 ... 6.3 MPa			
9.1 ... 914 psi			

¹⁾ The MAWP value of the pressure transmitter can be lower than the PN value of the mounting flange and vice versa. To determine the maximum permissible operating pressure and the maximum permissible test pressure, use the lowest value as reference.

Gauge pressure measuring limits with front-flush diaphragm	
Lower measuring limit	
• Measuring cell with silicone oil filling	100 mbar a/10 kPa a/1.45 psi a
• Measuring cell with inert oil	100 mbar a/10 kPa a/1.45 psi a
• Measuring cell with FDA-compliant oil	100 mbar a/10 kPa a/1.45 psi a
Upper measuring limit	100% of max. range

7.1.3 Gauge pressure from the differential pressure series

Gauge pressure input from the differential pressure series			
Measured variable	Gauge pressure and differential pressure		
Measuring span (continuously adjustable) and maximum operating pressure (according to 2014/68/EU Pressure Equipment Directive)	Measuring span	Maximum permissible operating pressure MAWP (PS)	Max. permissible test pressure
	1 ... 20 mbar	160 bar	240 bar
	0.1 ... 2 kPa	16 MPa	24 MPa
	0.4015 ... 8.031 inH ₂ O	2320 psi	3480 psi
	1 ... 60 mbar	160 bar	240 bar
	0.1 ... 6 kPa	16 MPa	24 MPa
	0.4015 ... 24.09 inH ₂ O	2320 psi	3480 psi
	2.5 ... 250 mbar	160 bar	240 bar
	0.2 ... 25 kPa	16 MPa	24 MPa
	1.004 ... 100.4 inH ₂ O	2320 psi	3480 psi
	6 ... 600 mbar	160 bar	240 bar
	0.6 ... 60 kPa	16 MPa	24 MPa
	2.409 ... 240.9 inH ₂ O	2320 psi	3480 psi
	16 ... 1600 mbar	160 bar	240 bar
	1.6 ... 160 kPa	16 MPa	24 MPa
	6.424 ... 642.4 inH ₂ O	2320 psi	3480 psi
	50 ... 5000 mbar	160 bar	240 bar
	5 ... 500 kPa	16 MPa	24 MPa
	20.08 ... 2008 inH ₂ O	2320 psi	3480 psi
	0.3 ... 30 bar	160 bar	240 bar
	0.03 ... 3 MPa	16 MPa	24 MPa
	4.35 ... 435 psi	2320 psi	3480 psi
	5 ... 100 bar	160 bar	240 bar
	0.5 ... 10 MPa	16 MPa	24 MPa
	76.9 ... 1450 psi	2320 psi	3480 psi

Gauge pressure measuring limits from differential pressure series	
Lower measuring limit	
• Measuring cell with silicone oil filling	30 mbar a/3 kPa a/0.44 psi a
• Measuring cell with inert oil	30 mbar a/3 kPa a/0.44 psi a
• Measuring cell with FDA-compliant oil	100 mbar a/10 kPa a/1.45 psi a
Upper measuring limit	100% of max. range (for oxygen measurement: max. 100 bar/ 10 MPa/1450 psi and 60 °C ambient temperature/medium temperature)
Start of scale value	Between the measuring limits (continuously adjustable)

7.1.4 Absolute pressure from the gauge pressure series

Absolute pressure input from the gauge pressure series			
Measured variable	Absolute pressure		
Measuring span (continuously adjustable) or measuring range, max. operating pressure (in accordance with 2014/68/EU Pressure Equipment Directive) and max. test pressure (in accordance with DIN 16086)	Measuring span	Maximum permissible operating pressure MAWP (PS)	Maximum test pressure
	8.3 ... 250 mbar a	4 bar a	6 bar a
	0.83 ... 25 kPa a	0.4 MPa a	0.6 MPa a
	3 ... 100 inH ₂ O a	58 psi a	87 psi a
	43 ... 1300 mbar a	6.6 bar a	10 bar a
	4.3 ... 130 kPa a	0.66 MPa a	1 MPa a
	17 ... 525 inH ₂ O a	95 psi a	145 psi a
	166 ... 5000 mbar a	20 bar a	30 bar a
	16.6 ... 500 kPa a	2 MPa a	3 MPa a
	2.41 ... 72.5 psi a	290 psi a	435 psi a
	1 ... 30 bar a	65 bar a	100 bar a
	0.1 ... 3 MPa a	6.5 MPa a	10 MPa a
	14.5 ... 435 psi a	942 psi a	1450 psi a
	5.3 ... 160 bar a	240 bar a	380 bar a
	0.53 ... 16 MPa a	24 MPa a	38 MPa a
	77 ... 2321 psi a	3480 psi a	5511 psi a
	13.3 ... 400 bar a	400 bar a	600 bar a
	1.3 ... 40 MPa a	40 MPa a	60 MPa a
	192 ... 5801 psi a	5801 psi a	8702 psi a
	23.3 ... 700 bar a	800 bar a	800 bar a
2.3 ... 70 MPa a	80 MPa a	80 MPa a	
337 ... 10152 psi a	11603 psi a	11603 psi a	

Absolute pressure measuring limits from gauge pressure series

Lower measuring limit	
• Measuring cell with silicone oil filling	0 mbar a/kPa a/psi a
• Measuring cell with inert oil	
For process temperature -20 °C < ϑ ≤ 60 °C (-4 °F < ϑ ≤ +140 °F)	30 mbar a/3 kPa a/0.44 psi a
For process temperature 60 °C < ϑ ≤ 100 °C (max. 85 °C for measuring cell 30 bar) (140 °F < ϑ ≤ 212 °F (max. 185 °F for measuring cell 435 psi))	30 mbar a + 20 mbar a • (ϑ - 60 °C)/°C 3 kPa a + 2 kPa a • (ϑ - 60 °C)/°C 0.44 psi a + 0.29 psi a • (ϑ - 140 °F)/°F

Absolute pressure measuring limits from gauge pressure series

Upper measuring limit	100% of max. range (for oxygen measurement: max. 100 bar/10 MPa/1450 psi and 60 °C ambient temperature/medium temperature)
Start of scale value	Between the measuring limits (continuously adjustable)

7.1.5 Absolute pressure with front-flush diaphragm

Absolute pressure with front-flush diaphragm

Measured variable	Absolute pressure		
Measuring span (continuously adjustable) or measuring range, max. operating pressure and max. test pressure	Measuring span	Maximum permissible operating pressure MAWP (PS)	Maximum test pressure
	43 ... 1300 mbar a 4.3 ... 130 kPa a 17 ... 525 inH ₂ O a <hr/> 166 ... 5000 mbar a 16.6 ... 500 kPa a 2.41 ... 72.5 psi a <hr/> 1 ... 30 bar a 0.1 ... 3 MPa a 14.5 ... 435 psi a	Refer to the information on the nameplate of the pressure transmitter and the data on the mounting flange ¹⁾	
Depending on the process connection, the measuring span may differ from these values			

¹⁾The MAWP value of the pressure transmitter can be lower than the PN value of the mounting flange and vice versa. To determine the maximum permissible operating pressure and the maximum permissible test pressure, use the lowest value as reference.

Absolute pressure measuring limits with front-flush diaphragm

Lower measuring limit	
<ul style="list-style-type: none"> Measuring cell with silicone oil filling 	0 mbar a/kPa a/psi a
Upper measuring limit	100% of max. range
Start of scale value	Between the measuring limits (continuously adjustable)

7.1.6 Absolute pressure from the differential pressure series

Absolute pressure input from the differential pressure series			
Measured variable	Absolute pressure		
Measuring span (continuously adjustable) and maximum operating pressure (according to 2014/68/EU Pressure Equipment Directive)	Measuring span	Maximum permissible operating pressure MAWP (PS)	Max. permissible test pressure
	8.3 ... 250 mbar a	160 bar a	240 bar a
	0.83 ... 25 kPa a	16 MPa a	24 MPa a
	3 ... 100 inH ₂ O a	2320 psi a	3480 psi a
	43 ... 1300 mbar a	160 bar a	240 bar a
	4.3 ... 130 kPa a	16 MPa a	24 MPa a
	17 ... 525 inH ₂ O a	2320 psi a	3480 psi a
	166 ... 5000 mbar a	160 bar a	240 bar a
	16.6 ... 500 kPa a	16 MPa a	24 MPa a
	2.41 ... 72.5 psi a	2320 psi a	3480 psi a
	1 ... 30 bar a	160 bar a	240 bar a
	0.1 ... 3 MPa a	16 MPa a	24 MPa a
	14.5 ... 435 psi a	2320 psi a	3480 psi a
	5 ... 100 bar a	160 bar a	240 bar a
	0.5 ... 10 MPa a	16 MPa a	24 MPa a
76.9 ... 1450 psi a	2320 psi a	3480 psi a	

Absolute pressure measuring limits from differential pressure series

Lower measuring limit	
<ul style="list-style-type: none"> Measuring cell with silicone oil filling 	0 mbar a/kPa a/psi a
<ul style="list-style-type: none"> Measuring cell with inert liquid 	
For process temperature $-20\text{ °C} < \vartheta \leq 60\text{ °C}$ ($-4\text{ °F} < \vartheta \leq +140\text{ °F}$)	30 mbar a/3 kPa a/0.44 psi a
For process temperature $60\text{ °C} < \vartheta \leq 100\text{ °C}$ (max. 85 °C for measuring cell 30 bar) ($140\text{ °F} < \vartheta \leq 212\text{ °F}$ (max. 185 °F for measuring cell 435 psi))	$30\text{ mbar a} + 20\text{ mbar a} \cdot (\vartheta - 60\text{ °C})/\text{°C}$ $3\text{ kPa a} + 2\text{ kPa a} \cdot (\vartheta - 60\text{ °C})/\text{°C}$ $0.44\text{ psi a} + 0.29\text{ psi a} \cdot (\vartheta - 140\text{ °F})/\text{°F}$
Upper measuring limit	100% of max. range (for oxygen measurement: max. 100 bar/10 MPa/1450 psi and 60 °C ambient temperature/medium temperature)
Start of scale value	Between the measuring limits (continuously adjustable)

7.1.7 Differential pressure and flow

Differential pressure input and flow			
Measured variable	Differential pressure and flow		
Measuring span (continuously adjustable) and maximum operating pressure (according to 2014/68/EU Pressure Equipment Directive)	Measuring span	Maximum permissible operating pressure MAWP (PS)	Max. permissible test pressure
	1 ... 20 mbar	160 bar	240 bar
	0.1 ... 2 kPa	16 MPa	24 MPa
	0.4015 ... 8.031 inH ₂ O	2320 psi	3480 psi
	1 ... 60 mbar	160 bar	240 bar
	0.1 ... 6 kPa	16 MPa	24 MPa
	0.4015 ... 24.09 inH ₂ O	2320 psi	3480 psi
	2.5 ... 250 mbar	160 bar	240 bar
	0.2 ... 25 kPa	16 MPa	24 MPa
	1.004 ... 100.4 inH ₂ O	2320 psi	3480 psi
	6 ... 600 mbar	160 bar	240 bar
	0.6 ... 60 kPa	16 MPa	24 MPa
	2.409 ... 240.9 inH ₂ O	2320 psi	3480 psi
	16 ... 1600 mbar	160 bar	240 bar
	1.6 ... 160 kPa	16 MPa	24 MPa
	6.424 ... 642.4 inH ₂ O	2320 psi	3480 psi
	50 ... 5000 mbar	160 bar	240 bar
	5 ... 500 kPa	16 MPa	24 MPa
	20.08 ... 2008 inH ₂ O	2320 psi	3480 psi
	0.3 ... 30 bar	160 bar	240 bar
	0.03 ... 3 MPa	16 MPa	24 MPa
	4.35 ... 435 psi	2320 psi	3480 psi
	2.5 ... 250 mbar	420 bar	630 bar
	0.25 ... 25 kPa	42 MPa	63 MPa
	1.004 ... 100.4 inH ₂ O	6091 psi	9137 psi
	6 ... 600 mbar	420 bar	630 bar
	0.6 ... 60 kPa	42 MPa	63 MPa
	2.409 ... 240.9 inH ₂ O	6091 psi	9137 psi
	16 ... 1600 mbar	420 bar	630 bar
	1.6 ... 160 kPa	42 MPa	63 MPa
	6.424 ... 642.4 inH ₂ O	6091 psi	9137 psi
	50 ... 5000 mbar	420 bar	630 bar
	5 ... 500 kPa	42 MPa	63 MPa
	20.08 ... 2008 inH ₂ O	6091 psi	9137 psi
	0.3 ... 30 bar	420 bar	630 bar
	0.03 ... 3 MPa	42 MPa	63 MPa
	4.35 ... 435 psi	6091 psi	9137 psi

Technical data

7.1 Input

Differential pressure and flow measuring limits

Lower measuring limit

<ul style="list-style-type: none"> Measuring cell with silicone oil filling 	-100% of maximum measuring range or 30 mbar a /3 kPa a /0.44 psi a
<ul style="list-style-type: none"> Measuring cell with inert oil 	For process temperature $-20\text{ °C} < \vartheta \leq 60\text{ °C}$ ($-4\text{ °F} < \vartheta \leq +140\text{ °F}$)
	-100% of maximum measuring range or 30 mbar a /3 kPa a /0.44 psi a
	For process temperature $60\text{ °C} < \vartheta \leq 100\text{ °C}$ (max. 85 °C for measuring cell 30 bar with PN420) ($140\text{ °F} < \vartheta \leq 212\text{ °F}$ (max. 185 °F for measuring cell 435 psi))
	-100% of maximum measuring range or 30 mbar a /3 kPa a /0.44 psi a $30\text{ mbar a} + 20\text{ mbar a} \cdot (\vartheta - 60\text{ °C})/\text{°C}$ $3\text{ kPa a} + 2\text{ kPa a} \cdot (\vartheta - 60\text{ °C})/\text{°C}$ $0.44\text{ psi a} + 0.29\text{ psi a} \cdot (\vartheta - 140\text{ °F})/\text{°F}$
<ul style="list-style-type: none"> Measuring cell with FDA-compliant oil 	For process temperature $-10\text{ °C} < \vartheta \leq 100\text{ °C}$ ($-14\text{ °F} < \vartheta \leq +212\text{ °F}$)
	-100% of maximum measuring range or 100 mbar a /10 kPa a / 14.5 psi a.
Upper measuring limit	100% of max. range (for oxygen measurement: max. 100 bar/10 MPa/1450 psi and 60 °C ambient temperature/medium temperature)
Start of scale value	Between the measuring limits (continuously adjustable)

7.1.8 Level

Level input

Measured variable	Level	Maximum permissible operating pressure MAWP (PS)	Max. permissible test pressure
Measuring span (continuously adjustable) and maximum operating pressure (according to 2014/68/EU Pressure Equipment Directive)	Measuring span		
	25 ... 250 mbar	See mounting flange	
	2.5 ... 25 kPa		
	10 ... 100 inH ₂ O		
	25 ... 600 mbar		
	2.5 ... 60 kPa		
	10 ... 240 inH ₂ O		
	53 ... 1600 mbar		
	5.3 ... 160 kPa		
	21 ... 640 inH ₂ O		
166 ... 5000 mbar			
16.6 ... 500 kPa			
2.41 ... 72.5 psi			

Level measuring limits	
Lower measuring limit	
Measuring cell with silicone oil filling	-100% of max. measuring range or 30 mbar a/3 kPa a/0.44 psi a depending on the mounting flange
Measuring cell with inert oil	-100% of max. measuring range or 30 mbar a/3 kPa a/0.44 psi a depending on the mounting flange
Measuring cell with FDA-compliant oil	-100% of maximum measuring range or 100 mbar a /10 kPa a /1.45 psi a
Upper measuring limit	100% of max. range
Start of scale value	Between the measuring limits (continuously adjustable)

7.2 Measuring accuracy of SITRANS P320

7.2.1 Reference conditions

- In accordance with EN 60770-1
- Rising characteristic curve
- Lower range value 0 bar/kPa/psi
- Seal diaphragm stainless steel
- Measuring cell with silicone oil filling
- Room temperature 25 °C (77 °F)

7.2.2 Effect of auxiliary power supply

0.005% per 1 V (in percent per change in voltage)

7.2.3 Gauge pressure

Conformity error at limit point setting, including hysteresis and repeatability - gauge pressure		
Measuring span ratio r (spread, Turn-Down)	r = max. measuring span/set measuring span and nominal measuring range	
• Linear characteristic curve	$r \leq 1.25$	$1.25 < r \leq 30$
250 mbar/25 kPa/3.6 psi	$\leq 0.075\%$	$\leq (0.008 \cdot r + 0.055)\%$
• Linear characteristic curve	$r \leq 5$	$5 < r \leq 100$

7.2 Measuring accuracy of SITRANS P320

Conformity error at limit point setting, including hysteresis and repeatability - gauge pressure		
1 bar/100 kPa/14.5 psi	≤ 0.065%	≤ (0.004 • r + 0.045)%
4 bar/400 kPa/58 psi		
16 bar/1.6 MPa/232 psi		
63 bar/6.3 MPa/914 psi		
160 bar/16 MPa/12321 psi		

• Linear characteristic curve	$r \leq 3$	$3 < r \leq 100$
	400 bar/40 MPa/5802 psi 700 bar/70 MPa/10152 psi	≤ 0.075%

Effect of ambient temperature - gauge pressure	
In percent per 28 °C (50 °F)	
250 mbar/25 kPa/3.6 psi	≤ (0.16 • r + 0.1)%
1 bar/100 kPa/14.5 psi	≤ (0.05 • r + 0.1)%
4 bar/400 kPa/58 psi	≤ (0.025 • r + 0.125)%
16 bar/1.6 MPa/232 psi	
63 bar/6.3 MPa/914 psi	
160 bar/16 MPa/2321 psi	
400 bar/40 MPa/5802 psi	
700 bar/70 MPa/10152 psi	≤ (0.08 • r + 0.16)%

Long-term stability at ±30 °C (±54 °F) - gauge pressure	
250 mbar/25 kPa/3.6 psi	Per year ≤ (0.25 • r)%
1 bar/100 kPa/14.5 psi	In 5 years ≤ (0.25 • r)% In 10 years ≤ (0.35 • r)%
4 bar/400 kPa/58 psi	In 5 years ≤ (0.125 • r)%
16 bar/1.6 MPa/232 psi	In 10 years ≤ (0.15 • r)%
63 bar/6.3 MPa/914 psi	
160 bar/16 MPa/2321 psi	
400 bar/40 MPa/5802 psi	
700 bar/70 MPa/10152 psi	In 5 years ≤ (0.25 • r)% In 10 years ≤ (0.35 • r)%

Step response time T_{63} (without electrical damping) - gauge pressure
Approx. 0.105 s

Effect of mounting position - gauge pressure
≤ 0.05 mbar/0.005 kPa/0.000725 psi per 10° incline (correct the zero point with position error compensation)

7.2.4 Gauge pressure from the differential pressure series

Conformity error at limit point setting, including hysteresis and repeatability - gauge pressure from the differential pressure series

Measuring span ratio r (spread, Turn-Down)	r = max. measuring span/set measuring span and nominal measuring range	
<ul style="list-style-type: none"> Linear characteristic curve 	$r \leq 5$	$5 < r \leq 20$
20 mbar/2 kPa/8.031 inH ₂ O	$\leq 0.075\%$	$\leq (0.005 \cdot r + 0.05)\%$
<ul style="list-style-type: none"> Linear characteristic curve 	$r \leq 5$	$5 < r \leq 60$
60 mbar/6 kPa/24.09 inH ₂ O	$\leq 0.075\%$	$\leq (0.005 \cdot r + 0.05)\%$
<ul style="list-style-type: none"> Linear characteristic curve 	$r \leq 5$	$5 < r \leq 100$
250 mbar/25 kPa/3.6 psi	$\leq 0.065\%$	$\leq (0.004 \cdot r + 0.045)\%$
600 mbar/60 kPa/240.9 inH ₂ O		
1600 mbar/160 kPa/642.4 inH ₂ O		
5000 mbar/500 kPa/2008 inH ₂ O		
30 bar/3 MPa/435 psi		
<ul style="list-style-type: none"> Linear characteristic curve 	$r \leq 10$	$10 < r \leq 30$
100 bar/10 MPa/1450.3 psi	$\leq 0.1\%$	$\leq 0.2\%$

Effect of ambient temperature - gauge pressure from differential pressure series

In percent per 28 °C (50 °F)	
20 mbar/2 kPa/8.031 inH ₂ O	$\leq (0.15 \cdot r + 0.1)\%$
60 mbar/6 kPa/24.09 inH ₂ O	$\leq (0.075 \cdot r + 0.1)\%$
250 mbar/25 kPa/3.6 psi	$\leq (0.025 \cdot r + 0.125)\%$
600 mbar/60 kPa/240.9 inH ₂ O	
1600 mbar/160 kPa/642.4 inH ₂ O	
5000 mbar/500 kPa/2008 inH ₂ O	
30 bar/3 MPa/435 psi	
100 bar/10 MPa/1450.3 psi	$\leq (0.08 \cdot r + 0.16)$

Long-term stability at ±30 °C (±54 °F) - gauge pressure from differential pressure series

20 mbar/2 kPa/8.031 inH ₂ O	Per year $\leq (0.2 \cdot r)\%$
60 mbar/6 kPa/24.09 inH ₂ O	In 5 years $\leq (0.25 \cdot r)\%$
250 mbar/25 kPa/3.6 psi	In 5 years $\leq (0.125 \cdot r)\%$
600 mbar/60 kPa/240.9 inH ₂ O	In 10 years $\leq (0.15 \cdot r)\%$
1600 mbar/160 kPa/642.4 inH ₂ O	
5000 mbar/500 kPa/2008 inH ₂ O	
30 bar/3 MPa/435 psi	In 5 years $\leq (0.25 \cdot r)\%$
	In 10 years $\leq (0.35 \cdot r)\%$
100 bar/10 MPa/1450.3 psi	In 5 years $\leq (0.25 \cdot r)\%$

7.2 Measuring accuracy of SITRANS P320

Step response time T_{63} (without electrical damping) - gauge pressure from differential pressure series	
20 mbar/2 kPa/8.031 inH ₂ O	Approx. 0.160 s
60 mbar/6 kPa/24.09 inH ₂ O	Approx. 0.150 s
250 mbar/25 kPa/3.6 psi	Approx. 0.135 s
600 mbar/60 kPa/240.9 inH ₂ O	
1600 mbar/160 kPa/642.4 inH ₂ O	
5000 mbar/500 kPa/2008 inH ₂ O	
30 bar/3 MPa/435 psi	
100 bar/10 MPa/1450.3 psi	Approx. 0.145 s

Effect of mounting position - gauge pressure from differential pressure series
≤ 0.7 mbar/0.007 kPa/0.01015266 psi per 10° incline (correct the zero point with position error compensation)

7.2.5 Absolute pressure from gauge and differential pressure series

Conformity error at limit point setting, including hysteresis and repeatability - absolute pressure from gauge and differential pressure series		
Measuring span ratio r (spread, Turn-Down)	$r = \text{max. measuring span/set measuring span and nominal measuring range}$	
• Linear characteristic curve	$r \leq 10$	$10 < r \leq 30$
All measuring cells	$\leq 0.1\%$	$\leq 0.2\%$

Effect of ambient temperature - absolute pressure from gauge and differential pressure series	
In percent per 28 °C (50 °F)	
250 mbar/25 kPa/3.6 psi	$\leq (0.15 \cdot r + 0.1)$
1300 mbar a/130 kPa a/18.8 psi a	$\leq (0.08 \cdot r + 0.16)$
5 bar a/500 kPa a/72.5 psi a	
30 bar a/3000 kPa a/435 psi a	
100 bar a/10 MPa a/1450.3 psi a	
160 bar a/16 MPa a/2321 psi a	
400 bar a/40 MPa a/5802 psi a	
700 bar a/70 MPa a/10152.6 psi a	

Long-term stability at ± 30 °C (± 54 °F) - absolute pressure from gauge and differential pressure series
In 5 years $\leq (0.25 \cdot r)\%$

Step response time T_{63} (without electrical damping) - absolute pressure from gauge and differential pressure series

Gauge pressure series

All measuring cells Approx. 0.105 s

Differential pressure series

250 mbar/25 kPa/3.6 psi Approx. 0.195 s

1300 mbar a/130 kPa a/18.8 psi a Approx. 0.145 s

5 bar a/500 kPa a/72.5 psi a

30 bar a/3000 kPa a/435 psi a

100 bar a/10 MPa a/1450.3 psi a

Effect of mounting position - absolute pressure from gauge and differential pressure series

In pressure per change of angle

- For absolute pressure (from the gauge pressure series): ≤ 0.05 mbar/0.005 kPa/
0.000725 psi per 10° incline
- For absolute pressure (from the differential pressure series): 0.7 mbar/0.07 kPa/
0.001015 psi per 10° incline

(zero-point correction is possible using the zero point adjustment)

7.2.6 Absolute pressure with front-flush diaphragm

Conformity error at limit point setting, including hysteresis and repeatability

Measuring span ratio r (spread, Turn-Down) $r = \text{max. measuring span/set measuring span and nominal measuring range}$

Linear characteristic curve $r \leq 10$ $10 < r \leq 30$

All measuring cells $\leq 0.2\%$ $\leq 0.4\%$

Effect of ambient temperature

In percent per 28°C (50°F)

All measuring cells $\leq (0.16 \cdot r + 0.24)$

Long-term stability at $\pm 30^\circ\text{C}$ ($\pm 54^\circ\text{F}$)

All measuring cells In 5 years $\leq (0.25 \cdot r)\%$

Step response time T_{63} (without electrical damping)

Approx. 0.105 s

Effect of mounting position

In pressure per change of angle
 0.04 kPa/0.4 mbar/0.006 psi per 10° incline
 (zero-point correction is possible with position error compensation)

7.2.7 Gauge pressure with front-flush diaphragm

Conformity error at limit point setting, including hysteresis and repeatability - gauge pressure with front-flush diaphragm

Measuring span ratio r (spread, Turn-Down) $r = \text{max. measuring span} / \text{set measuring span and nominal measuring range}$

• Linear characteristic curve	$r \leq 5$	$5 < r \leq 100$
1 bar/100 kPa/14.5 psi	$\leq 0.075\%$	$\leq (0.005 \cdot r + 0.05)\%$
4 bar/400 kPa/58 psi		
16 bar/1.6 MPa/232 psi		
63 bar/6.3 MPa/914 psi		

Effect of ambient temperature - gauge pressure with front-flush diaphragm

In percent per 28 °C (50 °F)

1 bar/100 kPa/14.5 psi	$\leq (0.08 \cdot r + 0.16)\%$
4 bar/400 kPa/58 psi	
16 bar/1.6 MPa/232 psi	
63 bar/6.3 MPa/914 psi	

Long-term stability at ±30 °C (±54 °F) - gauge pressure with front-flush diaphragm

1 bar/100 kPa/14.5 psi	In 5 years $\leq (0.25 \cdot r)\%$
4 bar/400 kPa/58 psi	
16 bar/1.6 MPa/232 psi	In 5 years $\leq (0.125 \cdot r)\%$
63 bar/6.3 MPa/914 psi	

Step response time T_{63} (without electrical damping) - gauge pressure with front-flush diaphragm

Approx. 0.105 s

Effect of mounting position - gauge pressure with front-flush diaphragm

≤ 0.4 mbar/0.04 kPa/0.006 psi per 10° incline
 (zero-point correction is possible with position error compensation)

7.2.8 Differential pressure and flow

Conformity error at limit point setting, including hysteresis and repeatability - differential pressure and flow		
Measuring span ratio r (spread, Turn-Down)	r = max. measuring span/set measuring span and nominal measuring range	
Linear characteristic curve	r ≤ 5	5 < r ≤ 20
20 mbar/2 kPa/0.29 psi	≤ 0.075%	≤ (0.005 • r + 0.05)%
Linear characteristic curve	r ≤ 5	5 < r ≤ 60
60 mbar/6 kPa/0.87 psi	≤ 0.075%	≤ (0.005 • r + 0.05)%
Linear characteristic curve	r ≤ 5	5 < r ≤ 100
250 mbar/25 kPa/3.63 psi	≤ 0.065%	≤ (0.004 • r + 0.045)%
600 mbar/60 kPa/8.70 psi		
1600 mbar/160 kPa/23.21 psi		
5 bar/500 kPa/72.52 psi		
30 bar/3 MPa/435.11 psi		
Root extraction characteristic	r ≤ 5	5 < r ≤ 20
Flow > 50%		
20 mbar/2 kPa/0.29 psi	≤ 0.075%	≤ (0.005 • r + 0.05)%
Root extraction characteristic	r ≤ 5	5 < r ≤ 60
Flow > 50%		
60 mbar/6 kPa/0.87 psi	≤ 0.075%	≤ (0.005 • r + 0.05)%
Root extraction characteristic	r ≤ 5	5 < r ≤ 100
Flow > 50%		
250 mbar/25 kPa/3.63 psi	≤ 0.065%	≤ (0.004 • r + 0.045)%
600 mbar/60 kPa/8.70 psi		
1600 mbar/160 kPa/23.21 psi		
5 bar/500 kPa/72.52 psi		
30 bar/3 MPa/435.11 psi		
Root extraction characteristic	r ≤ 5	5 < r ≤ 20
Flow 25 ... 50%		
20 mbar/2 kPa/0.29 psi	≤ 0.15%	≤ (0.01 • r + 0.1)%
Root extraction characteristic	r ≤ 5	5 < r ≤ 60
Flow 25 ... 50%		
60 mbar/6 kPa/0.87 psi	≤ 0.15%	≤ (0.01 • r + 0.1)%
Root extraction characteristic	r ≤ 5	5 < r ≤ 100

7.2 Measuring accuracy of SITRANS P320

Conformity error at limit point setting, including hysteresis and repeatability - differential pressure and flow		
Flow 25 ... 50%		
250 mbar/25 kPa/3.63 psi	≤ 0.13%	≤ (0.008 • r + 0.09)%
600 mbar/60 kPa/8.70 psi		
1600 mbar/160 kPa/23.21 psi		
5 bar/500 kPa/72.52 psi		
30 bar/3 MPa/435.11 psi		

Effect of ambient temperature - differential pressure and flow		
In percent per 28 °C (50 °F)		
20 mbar/2 kPa/0.29 psi	≤ (0.15 • r + 0.1)%	
60 mbar/6 kPa/0.87 psi	≤ (0.075 • r + 0.1)%	
250 mbar/25 kPa/3.63 psi	≤ (0.025 • r + 0.125)%	
600 mbar/60 kPa/8.70 psi		
1600 mbar/160 kPa/23.21 psi		
5 bar/500 kPa/72.52 psi		
30 bar/3 MPa/435.11 psi		

Effect of static pressure - differential pressure and flow		
• On the lower range value		
20 mbar/2 kPa/0.29 psi	≤ (0.15 • r)% per 70 bar (zero-point correction is possible with position error compensation)	
60 mbar/6 kPa/0.87 psi	≤ (0.1 • r)% per 70 bar (zero-point correction is possible with position error compensation)	
250 mbar/25 kPa/3.63 psi		
600 mbar/60 kPa/8.70 psi		
1600 mbar/160 kPa/23.21 psi		
30 bar/3 MPa/435.11 psi		
5 bar/500 kPa/72.52 psi	≤ (0.15 • r)% per 70 bar (zero-point correction is possible with position error compensation)	
• On the measuring span		
20 mbar/2 kPa/0.29 psi	≤ 0.2% per 70 bar	
60 mbar/6 kPa/0.87 psi	≤ 0.1% per 70 bar	
250 mbar/25 kPa/3.63 psi		
600 mbar/60 kPa/8.70 psi		
1600 mbar/160 kPa/23.21 psi		
5 bar/500 kPa/72.52 psi		
30 bar/3 MPa/435.11 psi		

Long-term stability at ±30 °C (±54 °F) - differential pressure and flow		
Static pressure max. 70 bar/7 MPa/1015 psi		
20 mbar/2 kPa/0.29 psi	Per year ≤ (0.2 • r)%	
60 mbar/6 kPa/0.87 psi	In 5 years ≤ (0.25 • r)%	

Long-term stability at ± 30 °C (± 54 °F) - differential pressure and flow

250 mbar/25 kPa/3.63 psi	In 5 years $\leq (0.125 \cdot r)\%$
600 mbar/60 kPa/8.70 psi	In 10 years $\leq (0.15 \cdot r)\%$
1600 mbar/160 kPa/23.21 psi	
5 bar/500 kPa/72.52 psi	
30 bar/3 MPa/435.11 psi	In 5 years $\leq (0.25 \cdot r)\%$
	In 10 years $\leq (0.35 \cdot r)\%$

Step response time T_{63} (without electrical damping) - - differential pressure and flow (PN160)

20 mbar/2 kPa/0.29 psi	Approx. 0.160 s
60 mbar/6 kPa/0.87 psi	Approx. 0.150 s
250 mbar/25 kPa/3.63 ps	Approx. 0.135 s
600 mbar/60 kPa/8.70 psi	
1600 mbar/160 kPa/23.21 psi	
5 bar/500 kPa/72.52 psi	
30 bar/3 MPa/435.11 psi	

Step response time T_{63} (without electrical damping) - - differential pressure and flow (PN420)

250 mbar/25 kPa/3.63 psi	Approx. 0.25 s
600 mbar/60 kPa/8.70 psi	Approx. 0.2 s
1600 mbar/160 kPa/23.21 psi	
5 bar/500 kPa/72.52 psi	
30 bar/3 MPa/435.11 psi	

Effect of mounting position - differential pressure and flow

Effect of mounting position	In pressure per change of angle ≤ 0.7 mbar/0.07 kPa/0.028 inH ₂ O per 10° incline (zero-point correction is possible with position error compensation)
-----------------------------	--

7.2.9 Level

Conformity error at limit point setting, including hysteresis and repeatability - level		
Measuring span ratio r (spread, Turn-Down)	r = max. measuring span/set measuring span and nominal measuring range	
• Linear characteristic curve	r ≤ 5	5 < r ≤ 10
250 mbar/25 kPa/3.63 psi	≤ 0.065%	≤ (0.004 • r + 0.045)%
600 mbar/60 kPa/8.70 psi		
1600 mbar/160 kPa/23.21 psi		
5 bar/500 kPa/72.52 psi		
Effect of ambient temperature¹⁾ - level		
In percent per 28 °C (50 °F)		
250 mbar/25 kPa/3.63 psi	≤ (0.025 • r + 0.125)%	
600 mbar/60 kPa/8.70 psi		
1600 mbar/160 kPa/23.21 psi		
5 bar/500 kPa/72.52 psi		
1) Data only applies to the basic unit. The error of the remote seal must be considered additively.		
Effect of static pressure - level		
• On the lower range value		
250 mbar/25 kPa/3.63 psi	≤ (0.1 • r)% per 70 bar (zero-point correction is possible with position error compensation)	
600 mbar/60 kPa/8.70 psi		
1600 mbar/160 kPa/23.21 psi		
5 bar/500 kPa/72.52 psi	≤ (0.15 • r)% per 70 bar (zero-point correction is possible with position error compensation)	
• On the measuring span		
	≤ (0.1 • r)% per 70 bar	
Long-term stability at ±30 °C (±54 °F) - level		
All measuring cells	In 5 years ≤ (0.25 • r)% static pressure max. 70 bar/7 MPa/1015 psi	
Effect of mounting position - level		
Depends on the fill fluid in the mounting flange		

7.3 Measuring accuracy of SITRANS P420

7.3.1 Reference conditions

- In accordance with EN 60770-1
- Rising characteristic curve
- Lower range value 0 bar/kPa/psi
- Seal diaphragm stainless steel
- Measuring cell with silicone oil filling
- Room temperature 25 °C (77 °F)

7.3.2 Effect of auxiliary power supply

0.005% per 1 V (in percent per change in voltage)

7.3.3 Gauge pressure

Conformity error at limit point setting, including hysteresis and repeatability - gauge pressure		
Measuring span ratio r (spread, Turn-Down)	r = max. measuring span/set measuring span and nominal measuring range	
• Linear characteristic curve	r ≤ 1.25	1.25 < r ≤ 30
250 mbar/25 kPa/3.6 psi	≤ 0.065%	≤ (0.008 • r + 0.055)%
• Linear characteristic curve	r ≤ 5	5 < r ≤ 100
1 bar/100 kPa/14.5 psi	≤ 0.04%	≤ (0.004 • r + 0.045)%
4 bar/400 kPa/58 psi		
16 bar/1.6 MPa/232 psi		
63 bar/6.3 MPa/914 psi		
160 bar/16 MPa/12321 psi		
• Linear characteristic curve	r ≤ 5	5 < r ≤ 100
400 bar/40 MPa/5802 psi	≤ 0.075%	≤ (0.005 • r + 0.05)%
700 bar/70 MPa/10152 psi		
Effect of ambient temperature - gauge pressure		
In percent per 28 °C (50 °F)		
250 mbar/25 kPa/3.6 psi	≤ (0.16 • r + 0.1)%	
1 bar/100 kPa/14.5 psi	≤ (0.05 • r + 0.1)%	

Technical data

7.3 Measuring accuracy of SITRANS P420

Effect of ambient temperature - gauge pressure	
4 bar/400 kPa/58 psi	$\leq (0.025 \cdot r + 0.125)\%$
16 bar/1.6 MPa/232 psi	
63 bar/6.3 MPa/914 psi	
160 bar/16 MPa/2321 psi	
400 bar/40 MPa/5802 psi	
700 bar/70 MPa/10152 psi	$\leq (0.08 \cdot r + 0.16)\%$

Long-term stability at ± 30 °C (± 54 °F) - gauge pressure	
250 mbar/25 kPa/3.6 psi	Per year $\leq (0.25 \cdot r)\%$
1 bar/100 kPa/14.5 psi	In 5 years $\leq (0.25 \cdot r)\%$ In 10 years $\leq (0.35 \cdot r)\%$
4 bar/400 kPa/58 psi	In 5 years $\leq (0.125 \cdot r)\%$
16 bar/1.6 MPa/232 psi	In 10 years $\leq (0.15 \cdot r)\%$
63 bar/6.3 MPa/914 psi	
160 bar/16 MPa/2321 psi	
400 bar/40 MPa/5802 psi	
700 bar/70 MPa/10152 psi	In 5 years $\leq (0.25 \cdot r)\%$ In 10 years $\leq (0.35 \cdot r)\%$

Step response time T_{63} (without electrical damping) - gauge pressure	
Approx. 0.105 s	

Effect of mounting position - gauge pressure	
≤ 0.05 mbar/0.005 kPa/0.000725 psi per 10° incline (zero-point correction is possible with position error compensation)	

7.3.4 Gauge pressure from the differential pressure series

Conformity error at limit point setting, including hysteresis and repeatability - gauge pressure from differential pressure series		
Measuring span ratio r (spread, Turn-Down)	$r = \text{max. measuring span/set measuring span and nominal measuring range}$	
• Linear characteristic curve	$r \leq 5$	$5 < r \leq 20$
20 mbar/2 kPa/8.031 inH ₂ O	$\leq 0.075\%$	$\leq (0.005 \cdot r + 0.05)\%$
• Linear characteristic curve	$r \leq 5$	$5 < r \leq 60$
60 mbar/6 kPa/24.09 inH ₂ O	$\leq 0.075\%$	$\leq (0.005 \cdot r + 0.05)\%$
• Linear characteristic curve	$r \leq 5$	$5 < r \leq 100$

Conformity error at limit point setting, including hysteresis and repeatability - gauge pressure from differential pressure series

	250 mbar/25 kPa/3.6 psi	$\leq 0.04\%$	$\leq (0.004 \cdot r + 0.045)\%$
	600 mbar/60 kPa/240.9 inH ₂ O		
	1600 mbar/160 kPa/642.4 inH ₂ O		
	5000 mbar/500 kPa/2008 inH ₂ O		
	30 bar/3 MPa/435 psi		
• Linear characteristic curve	100 bar/10 MPa/1450.3 psi	$r \leq 10$	$10 < r \leq 30$
		$\leq 0.1\%$	$\leq 0.2\%$

Effect of ambient temperature - gauge pressure from differential pressure series

In percent per 28 °C (50 °F)			
	20 mbar/2 kPa/8.031 inH ₂ O	$\leq (0.15 \cdot r + 0.1)\%$	
	60 mbar/6 kPa/24.09 inH ₂ O	$\leq (0.075 \cdot r + 0.1)\%$	
	250 mbar/25 kPa/3.6 psi	$\leq (0.025 \cdot r + 0.0625)\%$	
	5000 mbar/500 kPa/2008 inH ₂ O		
	600 mbar/60 kPa/240.9 inH ₂ O	$\leq (0.0125 \cdot r + 0.0625)\%$	
	1600 mbar/160 kPa/642.4 inH ₂ O		
	30 bar/3 MPa/435 psi		
	100 bar/10 MPa/1450.3 psi	$\leq (0.08 \cdot r + 0.16)\%$	

Long-term stability at ±30 °C (±54 °F) - gauge pressure from differential pressure series

	20 mbar/2 kPa/8.031 inH ₂ O	Per year $\leq (0.2 \cdot r)\%$
	60 mbar/6 kPa/24.09 inH ₂ O	In 5 years $\leq (0.25 \cdot r)\%$
	250 mbar/25 kPa/3.6 psi	In 5 years $\leq (0.125 \cdot r)\%$
	600 mbar/60 kPa/240.9 inH ₂ O	In 10 years $\leq (0.15 \cdot r)\%$
	1600 mbar/160 kPa/642.4 inH ₂ O	
	5000 mbar/500 kPa/2008 inH ₂ O	
	30 bar/3 MPa/435 psi	In 5 years $\leq (0.25 \cdot r)\%$
		In 10 years $\leq (0.35 \cdot r)\%$
	100 bar/10 MPa/1450.3 psi	In 5 years $\leq (0.25 \cdot r)\%$

Step response time T₆₃ (without electrical damping) - gauge pressure from differential pressure series

	20 mbar/2 kPa/8.031 inH ₂ O	Approx. 0.160 s
	60 mbar/6 kPa/24.09 inH ₂ O	Approx. 0.150 s
	250 mbar/25 kPa/3.6 psi	Approx. 0.135 s
	600 mbar/60 kPa/240.9 inH ₂ O	
	1600 mbar/160 kPa/642.4 inH ₂ O	
	5000 mbar/500 kPa/2008 inH ₂ O	
	30 bar/3 MPa/435 psi	
	100 bar/10 MPa/1450.3 psi	Approx. 0.145 s

7.3 Measuring accuracy of SITRANS P420

Effect of mounting position

≤ 0.7 mbar/0.007 kPa/0.01015266 psi per 10° incline
(zero-point correction is possible with position error compensation)

7.3.5 Absolute pressure from gauge and differential pressure series

Conformity error at limit point setting, including hysteresis and repeatability - absolute pressure from gauge and differential pressure series

Measuring span ratio r (spread, Turn-Down)	r = max. measuring span/set measuring span and nominal measuring range	
• Linear characteristic curve	r ≤ 10	10 < r ≤ 30
All measuring cells	≤ 0.1%	≤ 0.2%

Effect of ambient temperature - absolute pressure from gauge and differential pressure series

In percent per 28 °C (50 °F)

250 mbar/25 kPa/3.6 psi	≤ (0.15 • r + 0.1)
1300 mbar a/130 kPa a/18.8 psi a	≤ (0.08 • r + 0.16)
5 bar a/500 kPa a/72.5 psi a	
30 bar a/3000 kPa a/435 psi a	
100 bar a/10 MPa a/1450.3 psi a	
160 bar a/16 MPa a/2321 psi a	
400 bar a/40 MPa a/5802 psi a	
700 bar a/70 MPa a/10152.6 psi a	

Long-term stability at ±30 °C (±54 °F) - absolute pressure from gauge and differential pressure series

In 5 years ≤ (0.25 • r)%

Step response time T₆₃ (without electrical damping) - absolute pressure from gauge and differential pressure series

Gauge pressure series

All measuring cells Approx. 0.105 s

Differential pressure series

250 mbar/25 kPa/3.6 psi	Approx. 0.195 s
1300 mbar a/130 kPa a/18.8 psi a	Approx. 0.145 s
5 bar a/500 kPa a/72.5 psi a	
30 bar a/3000 kPa a/435 psi a	
100 bar a/10 MPa a/1450.3 psi a	

Effect of mounting position - absolute pressure from gauge and differential pressure series

In pressure per change of angle

- For absolute pressure (from the gauge pressure series):
 $\leq 0.05 \text{ mbar}/0.005 \text{ kPa}/0.000725 \text{ psi}$ per 10° incline
 - For absolute pressure (from the differential pressure series): $0.7 \text{ mbar}/0.07 \text{ kPa}/0.001015 \text{ psi}$ per 10° incline
- (zero-point correction is possible with position error compensation)
-

7.3.6 Absolute pressure with front-flush diaphragm

Conformity error at limit point setting, including hysteresis and repeatability

Measuring span ratio r (spread, Turn-Down)	$r = \text{max. measuring span/set measuring span and nominal measuring range}$	
Linear characteristic curve	$r \leq 10$	$10 < r \leq 30$
All measuring cells	$\leq 0.2\%$	$\leq 0.4\%$

Effect of ambient temperature

In percent per 28°C (50°F)

All measuring cells	$\leq (0.16 \cdot r + 0.24)$
---------------------	------------------------------

Long-term stability at $\pm 30^\circ\text{C}$ ($\pm 54^\circ\text{F}$)

All measuring cells	In 5 years $\leq (0.25 \cdot r)\%$
---------------------	------------------------------------

Step response time T_{63} (without electrical damping)

Approx. 0.105 s

Effect of mounting position

In pressure per change of angle

$0.04 \text{ kPa}/0.4 \text{ mbar}/0.006 \text{ psi}$ per 10° incline

(zero-point correction is possible with position error compensation)

7.3.7 Gauge pressure with front-flush diaphragm

Conformity error at limit point setting, including hysteresis and repeatability - gauge pressure with front-flush diaphragm		
Measuring span ratio r (spread, Turn-Down)	r = max. measuring span/set measuring span and nominal measuring range	
• Linear characteristic curve	r ≤ 5	5 < r ≤ 100
1 bar/100 kPa/14.5 psi	≤ 0.075%	≤ (0.005 • r + 0.05)%
4 bar/400 kPa/58 psi		
16 bar/1.6 MPa/232 psi		
63 bar/6.3 MPa/914 psi		
Effect of ambient temperature - gauge pressure with front-flush diaphragm		
In percent per 28 °C (50 °F)		
1 bar/100 kPa/14.5 psi	≤ (0.08 • r + 0.16)%	
4 bar/400 kPa/58 psi		
16 bar/1.6 MPa/232 psi		
63 bar/6.3 MPa/914 psi		
Long-term stability at ±30 °C (±54 °F) - gauge pressure with front-flush diaphragm		
1 bar/100 kPa/14.5 psi	In 5 years ≤ (0.25 • r)%	
4 bar/400 kPa/58 psi		
16 bar/1.6 MPa/232 psi	In 5 years ≤ (0.125 • r)%	
63 bar/6.3 MPa/914 psi		
Step response time T₆₃ (without electrical damping) - gauge pressure with front-flush diaphragm		
Approx. 0.105 s		
Effect of mounting position - gauge pressure with front-flush diaphragm		
≤ 0.4 mbar/0.04 kPa/0.006 psi per 10° incline (zero-point correction is possible with position error compensation)		

7.3.8 Differential pressure and flow

Conformity error at limit point setting, including hysteresis and repeatability - differential pressure and flow		
Measuring span ratio r (spread, Turn-Down)	r = max. measuring span/set measuring span and nominal measuring range	
Linear characteristic curve	r ≤ 5	5 < r ≤ 20
20 mbar/2 kPa/0.29 psi	≤ 0.075%	≤ (0.005 • r + 0.05)%

Conformity error at limit point setting, including hysteresis and repeatability - differential pressure and flow		
Linear characteristic curve	$r \leq 5$	$5 < r \leq 60$
60 mbar/6 kPa/0.87 psi	$\leq 0.075\%$	$\leq (0.005 \cdot r + 0.05)\%$
Linear characteristic curve	$r \leq 5$	$5 < r \leq 100$
250 mbar/25 kPa/3.63 psi (PN160)	$\leq 0.04\%$	$\leq (0.004 \cdot r + 0.045)\%$
600 mbar/60 kPa/8.70 psi		
1600 mbar/160 kPa/23.21 psi		
5 bar/500 kPa/72.52 psi		
30 bar/3 MPa/435.11 psi		
250 mbar/25 kPa/3.63 psi (PN420)	$\leq 0.065\%$	
600 mbar/60 kPa/8.70 psi		
1600 mbar/160 kPa/23.21 psi		
5 bar/500 kPa/72.52 psi		
30 bar/3 MPa/435.11 psi		
Root extraction characteristic	$r \leq 5$	$5 < r \leq 20$
Flow > 50%		
• 20 mbar/2 kPa/0.29 psi	$\leq 0.075\%$	$\leq (0.005 \cdot r + 0.05)\%$
Root extraction characteristic	$r \leq 5$	$5 < r \leq 60$
Flow > 50%		
• 60 mbar/6 kPa/0.87 psi	$\leq 0.075\%$	$\leq (0.005 \cdot r + 0.05)\%$
Root extraction characteristic	$r \leq 5$	$5 < r \leq 100$
Flow > 50%		
• 250 mbar/25 kPa/3.63 psi	$\leq 0.04\%$	$\leq (0.004 \cdot r + 0.045)\%$
600 mbar/60 kPa/8.70 psi		
1600 mbar/160 kPa/23.21 psi		
5 bar/500 kPa/72.52 psi		
30 bar/3 MPa/435.11 psi		
Root extraction characteristic	$r \leq 5$	$5 < r \leq 20$
Flow 25 ... 50%		
• 20 mbar/2 kPa/0.29 psi	$\leq 0.15\%$	$\leq (0.01 \cdot r + 0.1)\%$
Root extraction characteristic	$r \leq 5$	$5 < r \leq 60$
Flow 25 ... 50%		
• 60 mbar/6 kPa/0.87 psi	$\leq 0.15\%$	$\leq (0.01 \cdot r + 0.1)\%$
Root extraction characteristic	$r \leq 5$	$5 < r \leq 100$

7.3 Measuring accuracy of SITRANS P420

Conformity error at limit point setting, including hysteresis and repeatability - differential pressure and flow		
Flow 25 ... 50%		
• 250 mbar/25 kPa/3.63 psi	≤ 0.08%	≤ (0.008 • r + 0.09)%
600 mbar/60 kPa/8.70 psi		
1600 mbar/160 kPa/23.21 psi		
5 bar/500 kPa/72.52 psi		
30 bar/3 MPa/435.11 psi		

Effect of ambient temperature - differential pressure and flow		
In percent per 28 °C (50 °F)		
20 mbar/2 kPa/0.29 psi	≤ (0.15 • r + 0.1)%	
60 mbar/6 kPa/0.87 psi	≤ (0.075 • r + 0.1)%	
250 mbar/25 kPa/3.63 psi	≤ (0.025 • r + 0.0625)%	
600 mbar/60 kPa/8.70 psi	≤ (0.0125 • r + 0.0625)%	
1600 mbar/160 kPa/23.21 psi		
5 bar/500 kPa/72.52 psi	≤ (0.025 • r + 0.0625)%	
30 bar/3 MPa/435.11 psi	≤ (0.0125 • r + 0.0625)%	

Effect of static pressure - differential pressure and flow		
• On the lower range value		
20 mbar/2 kPa/0.29 psi	≤ (0.15 • r)% per 70 bar (zero-point correction is possible with position error compensation)	
60 mbar/6 kPa/0.87 psi	≤ (0.1 • r)% per 70 bar (zero-point correction is possible with position error compensation)	
250 mbar/25 kPa/3.63 psi		
600 mbar/60 kPa/8.70 psi		
1600 mbar/160 kPa/23.21 psi		
30 bar/3 MPa/435.11 psi		
5 bar/500 kPa/72.52 psi	≤ (0.15 • r)% per 70 bar (zero-point correction is possible with position error compensation)	
• On the measuring span		
20 mbar/2 kPa/0.29 psi	≤ 0.2% per 70 bar	
60 mbar/6 kPa/0.87 psi	≤ 0.1% per 70 bar	
250 mbar/25 kPa/3.63 psi		
600 mbar/60 kPa/8.70 psi		
1600 mbar/160 kPa/23.21 psi		
5 bar/500 kPa/72.52 psi		
30 bar/3 MPa/435.11 psi		

Long-term stability at ±30 °C (±54 °F) - differential pressure and flow		
Static pressure max. 70 bar/7 MPa/1015 psi		
20 mbar/2 kPa/0.29 psi	Per year	≤ (0.2 • r)%
60 mbar/6 kPa/0.87 psi	In 5 years	≤ (0.25 • r)%

Long-term stability at ± 30 °C (± 54 °F) - differential pressure and flow

250 mbar/25 kPa/3.63 psi	In 5 years $\leq (0.125 \cdot r)\%$
600 mbar/60 kPa/8.70 psi	In 10 years $\leq (0.15 \cdot r)\%$
1600 mbar/160 kPa/23.21 psi	
5 bar/500 kPa/72.52 psi	
30 bar/3 MPa/435.11 psi	In 5 years $\leq (0.25 \cdot r)\%$
	In 10 years $\leq (0.35 \cdot r)\%$

Step response time T_{63} (without electrical damping) - - differential pressure and flow (PN160)

20 mbar/2 kPa/0.29 psi	Approx. 0.160 s
60 mbar/6 kPa/0.87 psi	Approx. 0.150 s
250 mbar/25 kPa/3.63 ps	Approx. 0.135 s
600 mbar/60 kPa/8.70 psi	
1600 mbar/160 kPa/23.21 psi	
5 bar/500 kPa/72.52 psi	
30 bar/3 MPa/435.11 psi	

Step response time T_{63} (without electrical damping) - - differential pressure and flow (PN420)

250 mbar/25 kPa/3.63 psi	Approx. 0.25 s
600 mbar/60 kPa/8.70 psi	Approx. 0.2 s
1600 mbar/160 kPa/23.21 psi	
5 bar/500 kPa/72.52 psi	
30 bar/3 MPa/435.11 psi	

Effect of mounting position - differential pressure and flow

Effect of mounting position	In pressure per change of angle ≤ 0.7 mbar/0.07 kPa/0.028 inH ₂ O per 10° incline (zero-point correction is possible with position error compensation)
-----------------------------	--

7.3.9 Level

Conformity error at limit point setting, including hysteresis and repeatability - level		
Measuring span ratio r (spread, Turn-Down)	r = max. measuring span/set measuring span and nominal measuring range	
• Linear characteristic curve	r ≤ 5	5 < r ≤ 10
250 mbar/25 kPa/3.63 psi	≤ 0.04%	≤ (0.004 • r + 0.045)%
600 mbar/60 kPa/8.70 psi		
1600 mbar/160 kPa/23.21 psi		
5 bar/500 kPa/72.52 psi		
Effect of ambient temperature¹⁾ - level		
In percent per 28 °C (50 °F)		
250 mbar/25 kPa/3.63 psi	≤ (0.025 • r + 0.0625)%	
5 bar/500 kPa/72.52 psi		
600 mbar/60 kPa/8.70 psi	≤ (0.125 • r + 0.0625)%	
1600 mbar/160 kPa/23.21 psi		
1) Data only applies to the basic unit. The error of the remote seal must be considered additively.		
Effect of static pressure - level		
• On the lower range value		
50 mbar/25 kPa/3.63 psi	≤ (0.1 • r)% per 70 bar (zero-point correction is possible with position error compensation)	
600 mbar/60 kPa/8.70 psi		
600 mbar/160 kPa/23.21 psi		
5 bar/500 kPa/72.52 psi	≤ (0.15 • r)% per 70 bar (zero-point correction is possible with position error compensation)	
• On the measuring span	≤ (0.1 • r)% per 70 bar	
Long-term stability at ±30 °C (±54 °F) - level		
All measuring cells	In 5 years ≤ (0.25 • r)% static pressure max. 70 bar/7 MPa/1015 psi	
Effect of mounting position - level		
Depends on the fill fluid in the mounting flange		

7.4 Operating conditions

Operating conditions for gauge pressure and absolute pressure (from the gauge pressure series)		
Ambient conditions		
<ul style="list-style-type: none"> Ambient temperature 		
Note	Observe the temperature class in hazardous areas.	
Enclosure		
Measuring cell with silicone oil filling	-40 ... +85 °C (-40 ... +185 °F)	
Measuring cell with inert oil for gauge pressure measuring cells 1, 4, 16 and 63 bar	-40 ... +85 °C (-40 ... +185 °F)	
Measuring cell with inert oil	-20 ... +85 °C (-4 ... +185 °F)	
Measuring cell with FDA-compliant oil	-10 ... +85 °C (14 ... +185 °F)	
Display	-20 ... +80 °C (-4 ... +185 °F)	
<ul style="list-style-type: none"> Storage temperature 	-50 ... +85 °C (-58 ... +185 °F) (for FDA-compliant oil: -20 ... +85 °C (-4 ... +185 °F))	
Climate class in accordance with IEC 60721-3-4	4K4H	
Degree of protection according to IEC/EN 60529/UL50-E	Enclosure with appropriate cable gland	IP66/Type 4X IP68 (2 hours at 1.5 m)
	Enclosure with mounted M12 connector and/or lightning protection	IP66/Type 4X
	Enclosure with mounted HAN connector	IP65
Electromagnetic compatibility		
Interference emission and interference immunity	In accordance with EN 61326 and NAMUR NE 21	
Process medium conditions		
<ul style="list-style-type: none"> Process temperature 		

7.4 Operating conditions

Operating conditions for gauge pressure and absolute pressure (from the gauge pressure series)		
Cell	Pressure	Temperature range
Measuring cell with sili-cone oil filling		-40 ... +100 °C (-40 ... +212 °F)
Measuring cell with inert oil	1 bar/100 kPa/3.6 psi	-40 ... +100 °C (-40 ... +212 °F)
	4 bar/400 kPa/58 psi	-40 ... +100 °C (-40 ... +212 °F)
	16 bar/1.6 MPa/232 psi	-40 ... +100 °C (-40 ... +212 °F)
	63 bar/6.3 MPa/914 psi	-40 ... +100 °C (-40 ... +212 °F)
	160 bar/16 MPa/2321 psi	-20 ... +100 °C (-4 ... +212 °F)
	400 bar/40 MPa/5802 psi	-20 ... +100 °C (-4 ... +212 °F)
	700 bar/70 MPa/10152 psi	-20 ... +100 °C (-4 ... +212 °F)
Measuring cell with FDA-compliant oil		-10 ... +100 °C (14 ... +212 °F)

Operating conditions for gauge pressure and absolute pressure with flush-mounted diaphragm		
Ambient conditions		
<ul style="list-style-type: none"> Ambient temperature 		
Note	Observe the temperature class in hazardous areas.	
Enclosure		
Measuring cell with sili-cone oil filling	-40 ... +85 °C (-40 ... +185 °F)	
Measuring cell with inert oil (different pressure classes)	1 bar/100 kPa/3.6 psi	-40 ... +100 °C (-40 ... +212 °F)
	4 bar/400 kPa/58 psi	-40 ... +100 °C (-40 ... +212 °F)
	16 bar/1.6 MPa/232 psi	-40 ... +100 °C (-40 ... +212 °F)
	63 bar/6.3 MPa/914 psi	-40 ... +100 °C (-40 ... +212 °F)
	160 bar/16 MPa/2321 psi	-20 ... +100 °C (-4 ... +212 °F)
	400 bar/40 MPa/5802 psi	-20 ... +100 °C (-4 ... +212 °F)
	700 bar/70 MPa/10152 psi	-20 ... +100 °C (-4 ... +212 °F)
Measuring cell with FDA-compliant oil	-10 ... +85 °C (14 ... 185 °F)	
Display	-20 ... +80 °C (-4 ... +176 °F)	
<ul style="list-style-type: none"> Storage temperature 	-50 ... +85 °C (-58 ... +185 °F) (with FDA-compliant oil: -20 ... + 85 °C (-4 ... +185 °F))	
Climate class in accordance with IEC 60721-3-4	4K4H	
Degree of protection according to IEC/EN 60529/UL50-E	Enclosure with appropriate cable gland	IP66/Type 4X IP68 (2 hours at 1.5 m)
	Enclosure with mounted M12 connector and/or lightning protection	IP66/Type 4X
	Enclosure with mounted HAN connector	IP65

Operating conditions for gauge pressure and absolute pressure with flush-mounted diaphragm

Electromagnetic compatibility

- Interference emission and interference immunity In accordance with EN 61326 and NAMUR NE 21

Process medium conditions

Process temperature¹⁾

- Measuring cell with silicone oil filling -40 ... +150°C (-40 ... +302 °F)
-40 ... +200°C (-40 ... +392 °F) with cooling extension
- Measuring cell with inert oil -20 ... +100 °C (-4 ... +212 °F)
- Measuring cell with FDA-compliant oil -10 ... +150°C (14 ... 302 °F)
-10 ... +200°C (14 ... 392 °F) with cooling extension

¹⁾ Observe the temperature limits in the process connection standards (e.g. DIN 32676 and DIN 11851) for the maximum process temperature for flush-mounted process connections.

Operating conditions for gauge pressure and absolute pressure (from the differential pressure series), differential pressure and flow rate

Installation conditions

- Installation instruction Any

Ambient conditions

- Ambient temperature

Note Observe the temperature class in hazardous areas.

Enclosure

Measuring cell with silicone oil filling -40 ... +85 °C (-40 ... +185 °F)

- Measuring cell 30 bar (435 psi), PN420
 - -20 ... +85 °C (-4 ... +185 °F)
 - For flow: -20 ... +85 °C (-4 ... +185 °F)

Measuring cell with inert oil -20 ... +85 °C (-4 ... +185 °F)

Measuring cell with FDA-compliant oil -10 ... +85 °C (14 ... 185 °F)

Display -20 ... +80 °C (-4 ... +185 °F)

- Storage temperature -50 ... +85 °C (-58 ... +185 °F)
(with FDA-compliant oil: -20 ... + 85 °C (-4 ... +185 °F))

Climate class in accordance with IEC 60721-3-4 4K4H

Degree of protection according to IEC/EN 60529/UL50-E	Enclosure with appropriate cable gland	IP66/Type 4X IP68 (2 hours at 1.5 m)
---	--	---

	Enclosure with mounted M12 connector and/or lightning protection	IP66/Type 4X
--	--	--------------

7.4 Operating conditions

Operating conditions for gauge pressure and absolute pressure (from the differential pressure series), differential pressure and flow rate

	Enclosure with mounted HAN connector	IP65
Electromagnetic compatibility		
Interference emission and interference immunity	In accordance with EN 61326 and NAMUR NE 21	
Process medium conditions		
<ul style="list-style-type: none"> Process temperature 		
Measuring cell with silicone oil filling	-40 ... +100 °C (-40 ... +212 °F)	
<ul style="list-style-type: none"> Measuring cell 30 bar (435 psi), PN420 	-20 ... +85 °C (-4 ... +185 °F)	
Measuring cell with inert oil	-20 ... +100 °C (-4 ... +212 °F)	
<ul style="list-style-type: none"> Measuring cell 30 bar (435 psi), PN420 	-20 ... +85 °C (-4 ... +185 °F)	
Measuring cell with FDA-compliant oil	-10 ... +100 °C (14 ... +212 °F)	
In conjunction with dust explosion protection	-40 ... +85 °C (-4 ... +185 °F)	

Operating conditions for level

Installation conditions		
<ul style="list-style-type: none"> Installation instruction 	Specified by the flange	
Ambient conditions		
<ul style="list-style-type: none"> Ambient temperature 		
Note	Observe the allocation of the max. permissible operating temperature to the max. permissible operating pressure of the relevant flange connection.	
Enclosure		
Measuring cell with silicone oil filling	-40 ... +85 °C (-40 ... +185 °F)	
Display	-20 ... +80 °C (-4 ... +185 °F)	
<ul style="list-style-type: none"> Storage temperature 	-50 ... +85 °C (-58 ... +185 °F)	
Climate class in accordance with IEC 60721-3-4	4K4H	
Degree of protection according to IEC/EN 60529/UL50-E	Enclosure with appropriate cable gland	IP66/Type 4X IP68 (2 hours at 1.5 m)
	Enclosure with mounted M12 connector and/or lightning protection	IP66/Type 4X

Operating conditions for level		
	Enclosure with mounted HAN connector	IP65
Electromagnetic compatibility		
Interference emission and interference immunity	In accordance with EN 61326 and NAMUR NE 21	
Process medium conditions		
<ul style="list-style-type: none"> Process temperature 		
Measuring cell with silicone oil filling	<ul style="list-style-type: none"> Plus side: See mounting flange Minus side: -40 ... +100 °C (-40 ... +212 °F) 	

7.5 Vibration resistance

General operating conditions	Gauge pressure series ¹⁾	Differential pressure series ²⁾
	Aluminum and stainless steel enclosure	Aluminum and stainless steel enclosure
Vibrations (sine) IEC 60068-2-6	2 ... 9 Hz at 0.3 mm	2 ... 9 Hz at 0.3 mm
	9 ... 200 Hz at 5 m/s ²	9 ... 200 Hz at 5 m/s ²
	1 octave/min	1 octave/min
	5 cycles/axis	5 cycles/axis
Continuous shocks (half-sine) IEC 60068-2-27	70 m/s ²	70 m/s ²
	30 ms	30 ms
	6 shocks/axis	6 shocks/axis
Continuous shocks (half-sine) IEC 60068-2-27	250 m/s ²	250 m/s ²
	6 ms	6 ms
	1000 shocks/axis	1000 shocks/axis

1) With bracket

2) Without bracket

Technical data

7.5 Vibration resistance

Operating conditions according to KTA 3503	Gauge pressure series¹⁾ Aluminum and stainless steel enclosure	Differential pressure series¹⁾ Aluminum and stainless steel enclosure
Vibrations (sine) IEC 60068-2-6	9 ... 35 Hz at 10 m/s ² 1 octave/min 1 cycle/axis	
Vibrations (sine) IEC 60068-2-6	5 ... 7 Hz at 20 mm 9 ... 100 Hz at 20 m/s ² 10 octave/min 1 cycle/axis	
Continuous shocks (half-sine) IEC 60068-2-27	300 m/s ² 11 ms 6 shocks/axis	

1) With bracket

Operating conditions according to IEC 61298-3 (2g normal)	Gauge pressure series¹⁾ Aluminum and stainless steel enclosure
Vibrations (sine) IEC 60068-2-6	10 ... 58 Hz at 0.3 mm 58 ... 1000 Hz at 20 m/s ² 1 octave/min 20 cycles/axis

1) With bracket

2) Without bracket

Operating conditions according to IEC 61298-3 (5g enhanced)	Differential pressure series¹⁾ Aluminum and stainless steel enclosure
Vibrations (sine) IEC 60068-2-6	10 ... 58 Hz at 0.7 mm 58 ... 1000 Hz at 50 m/s ² 1 octave/min 20 cycles/axis

1) Without bracket

Operating conditions for marine (only in combination with order option E):	Gauge pressure series ¹⁾²⁾	Differential pressure series ³⁾
DNV-GL (Det Norske Veritas/Germanischer Lloyd)	2 ... 25 Hz at 3.2 mm	25 ... 100 Hz at 40 m/s ²
Lloyd's Register	0.5 octave/min	1 frequency sweep/axis
Bureau Veritas	Amplification factor (Q) < 2, 30 Hz/90 min	Amplification factor (Q) > 2, resonant frequency/90 min
ABS (American Bureau of Shipping)		
RINA (Registro Italiano Navale)		
CCS (China Classification Society)		

- 1) Without bracket and aluminum enclosure
- 2) With bracket, aluminum and stainless steel enclosure
- 3) Without bracket, aluminum and stainless steel enclosure

7.6 Construction

Construction for gauge pressure and absolute pressure (from the gauge pressure series)	
Weight	Approx. 1.8 kg (3.9 lb) with aluminum enclosure Approx. 3.8 kg (8.3 lb) with stainless steel enclosure
Material	
<ul style="list-style-type: none"> • Wetted parts materials 	
Process connection	Stainless steel, material no. 1.4404/316L or Alloy C22, material no. 2.4602
Oval flange	Stainless steel, mat. no. 1.4404/316L
Seal diaphragm	Stainless steel, material no. 1.4404/316L or Alloy C276, material no. 2.4819
<ul style="list-style-type: none"> • Non-wetted parts materials 	
Electronics housing	<ul style="list-style-type: none"> • Low-copper die-cast aluminum GD-AISI 12 or stainless steel precision casting, mat. no. 1.4409/ CF-3M • Standard: Powder coating with polyurethane Option: 2 coats: Coat 1: epoxy-based; coat 2: Polyurethane • Stainless steel nameplate (1.4404/316L)
Mounting bracket	Steel, galvanized, stainless steel 1.4301/304, stainless steel 1.4404/316L

Construction for gauge pressure and absolute pressure (from the gauge pressure series)

Process connection	<ul style="list-style-type: none"> • Connection pin G¹/₂A in accordance with DIN EN 837-1 • Female thread ¹/₂-14 NPT • Oval flange (PN 160 (MAWP 2320 psi g)) with fastening screw thread: <ul style="list-style-type: none"> – ⁷/₁₆-20 UNF in accordance with EN 61518 – M10 in accordance with DIN 19213 • Oval flange (PN 420 (MAWP 2320 psi g)) with fastening screw thread: <ul style="list-style-type: none"> – ⁷/₁₆-20 UNF in accordance with EN 61518 – M12 in accordance with DIN 19213 • Male thread M20 x 1.5 and ¹/₂-14 NPT
Electrical connection	<p>Cable inlet using the following screwed joints:</p> <ul style="list-style-type: none"> • M20 x 1.5 • ¹/₂-14 NPT • Han 7D/Han 8D connector¹⁾ • M12 connector

¹⁾ Han 8D is identical to Han 8U.

Construction for gauge pressure, with flush mounted diaphragm

Weight (pressure transmitter without mounting flange)	<p>Approx. 1.8 kg (3.9 lb) with aluminum enclosure</p> <p>Approx. 3.8 kg (8.3 lb) with stainless steel enclosure</p>
---	--

Material

<ul style="list-style-type: none"> • Wetted parts materials 	
Process connection	Stainless steel, mat. no. 1.4404/316L
Seal diaphragm	Stainless steel, material no. 1.4404/316L or Alloy C276, material no. 2.4819
<ul style="list-style-type: none"> • Non-wetted parts materials 	
Electronics housing	<ul style="list-style-type: none"> • Low-copper die-cast aluminum GD-AISI 12 or stainless steel precision casting, mat. no. 1.4409/CF-3M • Standard: Powder coating with polyurethane D20 option: 2 coats: Coat 1: epoxy-based; coat 2: Polyurethane • Stainless steel nameplate (1.4404/316L)
Mounting bracket	Steel, galvanized, stainless steel 1.4301/304, stainless steel 1.4404/316L
Process connection	<ul style="list-style-type: none"> • Flanges as per EN and ASME • F&B and Pharma flange • BioConnect/BioControl • PMC style
Electrical connection	<p>Cable inlet using the following screwed joints:</p> <ul style="list-style-type: none"> • M20x1.5 • ¹/₂-14 NPTM • Han 7D/Han 8D connector¹⁾ • M12 connector

¹⁾ Han 8D is identical to Han 8U.

Construction for gauge pressure and absolute pressure (from the differential pressure series), differential pressure and flow rate

Weight	Approx. 3.9 kg (8.5 lb) with aluminum enclosure Approx. 5.9 kg (13 lb) with stainless steel enclosure
Material	
• Wetted parts materials	
Seal diaphragm	Stainless steel, mat. no. 1.4404/316L, Alloy C276, mat. no. 2.4819, Monel 400, mat. no. 2.4360, tantalum or gold
Pressure caps and vents	Stainless steel, mat. no. 1.4408 to PN 160, mat. no. 1.4571/316Ti for PN 420, Alloy C22, 2.4602 or Monel 400, mat. no. 2.4360
O-ring	FKM (Viton) or optionally: PTFE, FEP, FEPM and NBR
• Non-wetted parts materials	
Electronics housing	<ul style="list-style-type: none"> • Low-copper die-cast aluminum GD-AISI 12 or stainless steel precision casting, mat. no. 1.4409/CF-3M • Standard: Powder coating with polyurethane D20 option: 2 coats: Coat 1: epoxy-based; coat 2: Polyurethane • Stainless steel nameplate (1.4404/316L)
Pressure cap screws	Stainless steel ISO 3506-1 A4-70
Mounting bracket	Steel, galvanized, stainless steel 1.4301/304, stainless steel 1.4404/316L
Process connection	$1/4$ -18 NPT female thread and flange connection with $7/16$ -20 UNF fastening screw thread in accordance with EN 61518 or M10 fastening screw thread in accordance with DIN 19213 (M12 for PN 420 (MAWP 6092 psi))
Electrical connection	<p>Screw terminals</p> <p>Cable inlet using the following screwed joints:</p> <ul style="list-style-type: none"> • M20 x 1.5 • $1/2$-14 NPT • Han 7D/Han 8D connector¹⁾ • M12 connector

¹⁾ Han 8D is identical to Han 8U.

Construction for level

Weight	
• In accordance with EN (pressure transmitter with mounting flange, without tube)	Approx. 11 ... 13 kg (24.2 ... 28.7 lb) with aluminum enclosure Approx. 13 ... 15 kg (28.7 ... 33 lb) with stainless steel enclosure
• In accordance with ASME (pressure transmitter with mounting flange, without tube)	Approx. 11 ... 18 kg (24.2 ... 39.7 lb) with aluminum enclosure Approx. 13 ... 20 kg (28.7 ... 44 lb) with stainless steel enclosure
Material	
• Wetted parts materials	
Plus side	

Technical data

7.6 Construction

Construction for level	
<ul style="list-style-type: none"> Seal diaphragm on the mounting flange 	Stainless steel, mat. no. 1.4404/316L, Monel 400, mat. no. 2.4360, Alloy B2, mat. no. 2.4617, Alloy C276, mat. no. 2.4819, Alloy C22, mat. no. 2.4602, tantalum, PTFE
<ul style="list-style-type: none"> Sealing surface 	Smooth as per EN 1092-1, form B1 or ASME B16.5 RF 125 ... 250 AA for stainless steel 316L, EN 2092-1 form B2 or ASME B16.5 RFSF for the remaining materials
Sealing material in the pressure caps	
<ul style="list-style-type: none"> For standard applications 	FKM (Viton)
<ul style="list-style-type: none"> For underpressure applications on the mounting flange 	Copper
Minus side	
<ul style="list-style-type: none"> Seal diaphragm 	Stainless steel, mat. no. 1.4404/316L
<ul style="list-style-type: none"> Pressure caps locking screws 	Stainless steel, mat. no. 1.4408
<ul style="list-style-type: none"> Locking screw 	Stainless steel ISO 3506-1 A4-70
<ul style="list-style-type: none"> O-ring 	FKM (FKM (Viton))
<ul style="list-style-type: none"> Non-wetted parts materials 	
Electronics housing	<ul style="list-style-type: none"> Low-copper die-cast aluminum GD-AISI 12 or stainless steel precision casting, mat. no. 1.4409/CF-3M Standard: Powder coating with polyurethane D20 option: 2 coats: Coat 1: epoxy-based; coat 2: Polyurethane Stainless steel nameplate (1.4404/316L)
Pressure cap screws	Stainless steel ISO 3506-1 A4-70
Measuring cell filling	
<ul style="list-style-type: none"> Mounting flange fill fluid 	Silicone oil
Process connection	
<ul style="list-style-type: none"> Plus side 	Flange as per EN and ASME
<ul style="list-style-type: none"> Minus side 	$\frac{1}{4}$ -18 NPT female thread and flange connection with M10 fastening screw thread in accordance with DIN 19213 (M12 for PN 420 (MAWP 6092 psi)) or $\frac{7}{16}$ -20 UNF in accordance with EN 61518
Electrical connection	
	Screw terminals Cable inlet using the following screwed joints: <ul style="list-style-type: none"> M20 x 1.5 $\frac{1}{2}$-14 NPT Han 7D/Han 8D connector¹⁾ M12 connector

¹⁾ Han 8D is identical to Han 8U.



7.7 Torques

Torques	
Cable glands/blanking plugs	
• Screw-in torque for plastic gland in all enclosures	4 Nm (3 ft lb)
• Screw-in torque for metal/stainless steel glands in aluminum/stainless steel enclosure	6 Nm (4.4 ft lb)
• Screw-in torque for NPT adapter made of metal/stainless steel in aluminum/stainless steel enclosure	15 Nm (11.1 ft lb)
• Tightening torque for union nut made of plastic	2.5 Nm (1.8 ft lb)
• Tightening torque for union nut made of metal/stainless steel	4 Nm (3 ft lb)
Screws for mounting bracket (option)	
• Tightening torque for thread M8 or $\frac{5}{16}$ -24 UNF	18 Nm
• Tightening torque for thread M10 or $\frac{7}{16}$ -20 UNF	36 Nm
Retaining screws for rotation of the enclosure	
• Tightening torque for aluminum enclosure	3.8 Nm
• Tightening torque for stainless steel enclosure	3.5 Nm



7.8 Display, keyboard and auxiliary power

Display and user interface	
Buttons	4 buttons for operation directly on the device
Display	<ul style="list-style-type: none"> • With or without integrated display (optional) • Cover with inspection window (optional)
Auxiliary power U_H	
	HART
Terminal voltage on pressure transmitter	<ul style="list-style-type: none"> • DC 10.5 V ... 45 V • In the case of intrinsically safe operation 10.5 V ... 30 V DC
Ripple	$U_{SS} \leq 0.2 \text{ V}$ (47 ... 125 Hz)
Noise	$U_{eff} \leq 1.2 \text{ mV}$ (0.5 ... 10 kHz)
Auxiliary power	–
Separate supply voltage	–



7.9 Certificates and approvals

Certificates and approvals	
Classification according to pressure equipment directive (PED 2014/68/EU)	<ul style="list-style-type: none"> For gases of fluid group 1 and liquids of fluid group 1; complies with requirements of article 4, paragraph 3 (sound engineering practice) Only for flow rate: For gases of Fluid Group 1 and liquids of Fluid Group 1; fulfills the basic safety requirements as per article 3, Para 1 (appendix 1); classified as category III, module H conformity evaluation by TÜV Nord
Drinking water	Available soon
<ul style="list-style-type: none"> WRAS (England) ACS (France) DVGW (Germany) NSF (USA) 	
CRN (Canada)	Available soon
Explosion protection in accordance with NEPSI (China)	Available soon
Explosion protection in accordance with INMETRO (Brazil)	Available soon
BAM (Germany), oxygen expenditures	Available soon
Explosion protection	
<ul style="list-style-type: none"> Intrinsic safety "i" 	
Designation	 II 1/2 G Ex ia/ib IIC T4/T6 Ga/Gb
Permissible ambient temperature	-40 ... +80 °C (-40 ... +176 °F) temperature class T4 -40 ... +70 °C (-40 ... +158 °F) temperature class T6
Permissible temperature of medium	-40 ... +100 °C (-40 ... +212 °F) temperature class T4 -40 ... +70 °C (-40 ... +158 °F) temperature class T6
Connection	To a certified intrinsically safe circuit with the max. values: $U_i = 30 \text{ V}$, $I_i = 101 \text{ mA}$, $P_i = 760 \text{ mW}$ $U_i = 29 \text{ V}$, $I_i = 110 \text{ mA}$, $P_i = 800 \text{ mW}$
Effective inner capacitance	$C_i = 3.29 \text{ nF}$
Effective inner inductance	$L_i = 0.24 \text{ } \mu\text{H}$
<ul style="list-style-type: none"> Flameproof enclosure encapsulation "d" 	
Designation	 II 1/2G Ex ia/db IIC T4/T6 Ga/Gb
Permissible ambient temperature	-40 ... +80 °C (-40 ... +176 °F) temperature class T4 -40 ... +70 °C (-40 ... +158 °F) temperature class T6
Permissible temperature of medium	-40 ... +100 °C (-40 ... +212 °F) temperature class T4 -40 ... +70 °C (-40 ... +158 °F) temperature class T6
Connection	To a circuit with the operating values: $U_H = 10.5 \dots 45 \text{ V DC}$, $4 \dots 20 \text{ mA}$
<ul style="list-style-type: none"> Dust explosion protection for Zone 20, 21, 22 	



Certificates and approvals

Designation	 II 1D Ex tb IIIC T120 °C Da  II 2D Ex tb IIIC T120 °C Db  II 3D Ex tc IIIC T120 °C Dc
Permissible ambient temperature	-40 ... +80 °C (-40 ... +176 °F)
Permissible temperature of medium	-40 ... +100 °C (-40 ... +212 °F)
Max. surface temperature	120°C (248°F)
Connection	To a circuit with the operating values: $U_H = 10.5 \dots 45 \text{ V DC}, 4 \dots 20 \text{ mA}$

• Dust explosion protection for Zone 20, 21, 22

Designation	 II 1D Ex ia IIIC T120 °C Da  II 2D Ex ib IIIC T120 °C Db  II 3D Ex ic IIIC T120 °C Dc
Permissible ambient temperature	-40 ... +80 °C (-40 ... +176 °F)
Permissible temperature of medium	-40 ... +100 °C (-40 ... +212 °F)
Connection	To a certified intrinsically safe circuit with the max. values: $U_i = 30 \text{ V}, I_i = 101 \text{ mA}, P_i = 760 \text{ mW}$ $U_i = 29 \text{ V}, I_i = 110 \text{ mA}, P_i = 800 \text{ mW}$
Effective inner capacitance	$C_i = 3.29 \text{ nF}$
Effective inner inductance	$L_i = 0.24 \text{ } \mu\text{H}$

• Type of protection for Zone 2

Designation	 II 3G Ex ec IIC T4/T6 Gc  II 3G Ex ic IIC T4/T6 Gc
Permissible ambient temperature "ec"	-40 ... +80 °C (-40 ... +176 °F) temperature class T4 -40 ... +40 °C (-40 ... +104 °F) temperature class T6
Permissible ambient temperature "ic"	-40 ... +80 °C (-40 ... +176 °F) temperature class T4 -40 ... +80 °C (-40 ... +176 °F) temperature class T6
Permissible temperature of medium	-40 ... +100 °C (-40 ... +212 °F) temperature class T4 -40 ... +70 °C (-40 ... +158 °F) temperature class T6
Connection "ec"	To a circuit with the operating values: $U_n = 10.5 \text{ to } 30 \text{ V}, 4 \dots 20 \text{ mA}$
Connection "ic"	To a certified intrinsically safe circuit with the max. values: $U_i = 30 \text{ V}, I_i = 101 \text{ mA}, P_i = 760 \text{ mW}$ $U_i = 29 \text{ V}, I_i = 110 \text{ mA}, P_i = 800 \text{ mW}$ Effective inner capacitance $C_i = 3.29 \text{ nF}$ Effective inner inductance $L_i = 0.24 \text{ } \mu\text{H}$

• Explosion protection in accordance with FM

Designation (XP/DIP) or IS; NI; S	Available soon CL I, DIV 1, GP ABCD T4 ... T6; CL II, DIV 1, GP EFG; CL III; CL I, ZN 0/1 AEx ia IIC T4 ... T6; CL I, DIV 2, GP ABCD T4 ... T6; CL II, DIV 2, GP FG; CL III
-----------------------------------	--

• Explosion protection as per CSA

Designation (XP/DIP) or (IS)	Available soon CL I, DIV 1, GP ABCD T4 ... T6; CL II, DIV 1, GP EFG; CL III; Ex ia IIC T4 ... T6; CL I, DIV 2, GP ABCD T4 ... T6; CL II, DIV 2, GP FG; CL III
------------------------------	--

Appendix A

8.1 Technical support

Technical Support

If this documentation does not provide complete answers to any technical questions you may have, contact Technical Support at:

- Support request (<http://www.siemens.com/automation/support-request>)
- More information about our Technical Support is available at Technical support (<http://www.siemens.com/automation/csi/service>)

Internet Service & Support

In addition to our documentation, Siemens provides a comprehensive support solution at:

- Service&Support (<http://www.siemens.com/automation/service&support>)

Personal contact

If you have additional questions about the device, please contact your Siemens personal contact at:

- Partner (<http://www.automation.siemens.com/partner>)

To find the personal contact for your product, go to "All Products and Branches" and select "Products & Services > Industrial Automation > Process Instrumentation".

Documentation

You can find documentation on various products and systems at:

- Instructions and manuals (<http://www.siemens.com/processinstrumentation/documentation>)

See also

E-mail (<mailto:support.automation@siemens.com>)

Product information on SITRANS P in the Internet (<http://www.siemens.com/sitransp>)

Process instrumentation catalog (<http://www.siemens.com/processinstrumentation/catalogs>)

8.2 Certificates

You can find certificates on the Internet at Certificates (<http://www.siemens.com/processinstrumentation/certificates>) or on an included DVD.

Index

A

Ambient temperature, 83, 84, 85, 86
Effect, 67, 77

B

Blowout valve, 40
Blowout valves, 43

C

Certificates, 13, 98
Cleaning, 50
Compact Operating Instructions, 97
Customer Support, (Refer to Technical Support)

D

Direct sunlight, 20
Disassembly, 28
Disposal, 54
Document history, 7
Documentation, 97

E

Electromagnetic compatibility, 83, 85, 86, 87
EMC, 83, 85, 86, 87

F

Flange, 24

H

Hazardous area
Laws and directives, 13
Qualified personnel, 15
Hotline, (Refer to Support request)

I

Installation, 21

Instructions and manuals, 97

L

Laws and directives
Disassembly, 13
Personell, 13
Layout of nameplate with general information, 9

M

Manuals, 97
Modifications
correct usage, 14
improper, 14

N

Nameplate, 9

O

Operating Instructions, 97

Q

Qualified personnel, 15

R

Remote seal
Maintenance, 50
Return procedure, 53

S

Scope of delivery, 11
Service, 97
Service & Support, 97
Internet, 97
Shut-off valve, 41, 42, 45, 46
Stabilizing valve, 43, 45, 46
Support, 97
Support request, 97

T

Technical Support, 97
 Partner,
 Personal contact, 97
Test certificates, 13

V

Vent valve, 45, 46

W

Warranty, 12