



Flush-mount LCD
multimeters.
expandable
DMG610
Three-phase +
neutral

Product designation

Product type designation

Type

Auxiliary supply Us

Auxiliary rated supply voltage AC	VAC	100...440
Auxiliary rated supply voltage DC	VDC	120...250
Auxiliary operating voltage range		
AC		
	min	VAC 90
	Max	VAC 484
DC		
	min	VDC 93.5
	Max	VDC 300

Operational frequency		
	min	Hz 45
	max	Hz 66

Power consumption	Max	VA 9.5
-------------------	-----	--------

Power dissipation Max	W	3.5
-----------------------	---	-----

Measuring voltage inputs

Rated voltage (Ue)		
	phase-phase	VAC 600
	phase-neutral	VAC 300

Operating voltage range		
	phase-phase	VAC 50...720
	phase-neutral	VAC 30...360

Voltage inputs operational frequency		
	min	Hz 45
	max	Hz 66

Voltage inputs measurement method		True RMS
-----------------------------------	--	----------

Connection method		Single. two. three-phase with or without neutral. balanced three- phase system
-------------------	--	--

Current inputs

Rated current (Ie)	A	1A/5A
--------------------	---	-------

Measurement range		0.01...1.2 / 0.01...6
-------------------	--	--------------------------

Measurement method		TRMS
--------------------	--	------

Overload capacity		+20% Ie by external CT with 5A secondary
-------------------	--	--

Overload peak		A	50A for 1s
Accuracy			
	VLN voltage		±0.5%
	VLL voltage		±0.5%
	Current		±0.5%
	Frequency		±0.05%
	Active power		±0.5%
	Active energy		Class 1 (IEC/EN 62053-21)
	Reactive energy		Class 2 (IEC/EN 62053-23)
RS485 serial interface			
Baud rate		bps	Programmable 1200...115200
Insulations			
Rated insulation voltage Ui IEC/EN		V	600
Rated impulse withstand voltage Uimp		kV	9.5
Operating frequency withstand voltage		kV	5.2
Functions			
Harmonic analysis			15th order
PLC logic			No
Type of communication port			RS485
Ethernet-RS485 gateway function			No
Mechanical features			
Housing type			Polyamide
Terminals type			Removable
Conductor cross section			
	min	mm ²	0.2
	Max	mm ²	2.5
	min	AWG	24
	Max	AWG	12
Tightening torque (Max)			
		Nm	0.5
		lbin	4.5
Fixing			Flush-mounting
Weight		g	350
Ambient conditions			
Temperature			
	Operating temperature		
		min	°C -20
		max	°C +60
	Storage temperature		
		min	°C -30
		max	°C +80
Relative humidity		%	<90
Maximum Pollution degree			2
Protection degree			IP54
Dimensions [mm (in)]			

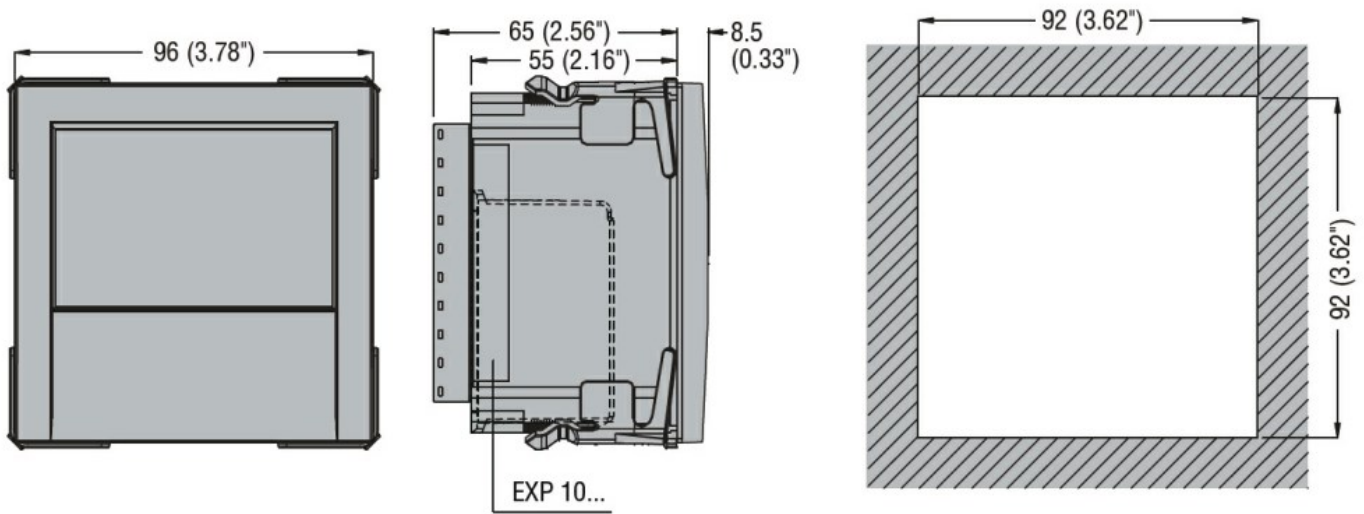

Wiring diagrams

Single-phase

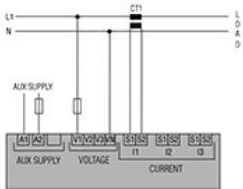

Two-phase

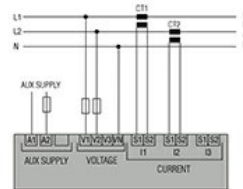

Three-phase with or without neutral

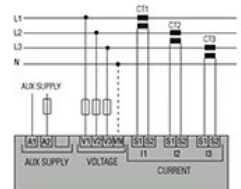

Three-phase without neutral in ARON connection

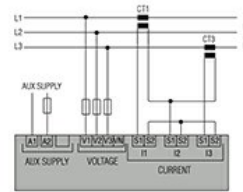
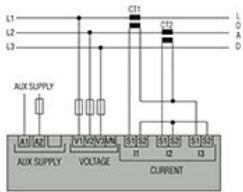

Balanced 3-phase connection with or without neutral

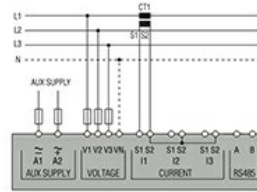

CODE	AUX SUPPLY
DMG100-110-200-210-300	100...240VAC 110...250VDC
DMG6...	100...440VAC 110...250VDC
DMG7000-7500-8000-9000	100...240VAC 110...250VDC



Certifications and compliance

Compliance

CSA 22.2 n°61010-1
IEC/EN 61000-6-2
IEC/EN 61000-6-3
IEC/EN 61010-1
IEC/EN 61010-2-030
UL61010-1

Certificates

cULus
EAC
GOST
RCM

ETIM classification

ETIM 8.0

EC002301 -
Multifunction
measuring
instrument