

# Relay Module - RIF-1-RPT-LDP-24DC/2X21 - 2903334

Please be informed that the data shown in this PDF Document is generated from our Online Catalog. Please find the complete data in the user's documentation. Our General Terms of Use for Downloads are valid (<http://phoenixcontact.com/download>)



Pre-assembled relay module with push-in connection, consisting of: relay base, power contact relay, plug-in display/suppressor module, and retaining bracket. Contact type: 2 PDTs. Input voltage: 24 V DC

## Product Description

The pluggable electromechanical and solid-state relays in the RIFLINE complete product range and the base are recognized and approved in accordance with UL 508. The relevant approvals can be called up at the individual components in question.



## Key Commercial Data

Packing unit	10 pc
GTIN	 4 046356 732277
GTIN	4046356732277
Weight per Piece (excluding packing)	64.000 g
Weight per piece (including packing)	71.288 g
Custom tariff number	85364110
Country of origin	China
Sales Key	G1 - Relay

## Technical data

### Note

Utilization restriction	EMC: class A product, see manufacturer's declaration in the download area
Type of note	Notes on operation
Note	FBS 2-6... plug-in bridge for the input side (A2) and FBS-2-8... plug-in bridge for the output side (11/21)

### Dimensions

Width	16 mm
Height	93 mm
Depth	75 mm

# Relay Module - RIF-1-RPT-LDP-24DC/2X21 - 2903334

## Technical data

### Ambient conditions

Ambient temperature (operation)	-40 °C ... 70 °C
Ambient temperature (storage/transport)	-40 °C ... 85 °C
Degree of protection	IP20 (Relay base)
	RT III (Relay)

### Coil side

Nominal input voltage $U_N$	24 V DC
Input voltage range in reference to $U_N$	see diagram
Typical input current at $U_N$	18 mA
Typical response time	8 ms
Typical release time	10 ms
Coil voltage	24 V DC
Protective circuit	Damping diode
Operating voltage display	Yellow LED
Power dissipation for nominal condition	0.43 W

### Contact side

Contact type	2 PDT
Type of switch contact	Single contact
Contact material	AgNi
Maximum switching voltage	250 V AC/DC
Minimum switching voltage	5 V (at 10 mA)
Min. switching current	10 mA (At 5 V)
Maximum inrush current	25 A (20 ms, N/O contact)
Limiting continuous current	8 A (see diagram)
Interrupting rating (ohmic load) max.	192 W (at 24 V DC)
	96 W (at 48 V DC)
	60 W (at 60 V DC)
	44 W (at 110 V DC)
	57 W (at 220 V DC)
	2000 VA (for 250 V AC)
Switching capacity	2 A (at 24 V, DC13)
	0.2 A (at 250 V, DC13)
	3 A (at 24 V, AC15)
	3 A (at 120 V, AC15)
	3 A (at 250 V, AC15)

### General

Test voltage relay winding/relay contact	4 kV <sub>rms</sub> (50 Hz, 1 min.)
Test voltage PDT/PDT	2.5 kV <sub>rms</sub> (50 Hz, 1 min.)
Operating mode	100% operating factor
Mechanical service life	approx. $3 \times 10^7$ cycles

# Relay Module - RIF-1-RPT-LDP-24DC/2X21 - 2903334

## Technical data

### General

Service life, electrical	see diagram
Mounting position	any
Assembly instructions	In rows with zero spacing

### Connection data

Connection name	Coil side
Connection method	Push-in connection
Stripping length	8 mm
Conductor cross section solid	0.14 mm <sup>2</sup> ... 1.5 mm <sup>2</sup>
Conductor cross section flexible	0.14 mm <sup>2</sup> ... 1.5 mm <sup>2</sup>
	0.14 mm <sup>2</sup> ... 1.5 mm <sup>2</sup> (Ferrule with plastic sleeve)
	0.14 mm <sup>2</sup> ... 1 mm <sup>2</sup> (Ferrule with plastic sleeve, two conductors on double terminal block)
Conductor cross section AWG	26 ... 16 (solid)
	26 ... 16 (flexible)

### Connection data 2

Connection name	Contact side
Connection method	Push-in connection
Stripping length	8 mm
Conductor cross section solid	0.14 mm <sup>2</sup> ... 1.5 mm <sup>2</sup>
Conductor cross section flexible	0.14 mm <sup>2</sup> ... 1.5 mm <sup>2</sup>
	0.14 mm <sup>2</sup> ... 1.5 mm <sup>2</sup> (Ferrule with plastic sleeve)
	0.14 mm <sup>2</sup> ... 1 mm <sup>2</sup> (Ferrule with plastic sleeve, two conductors on double terminal block)
Conductor cross section AWG	26 ... 16 (solid)
	26 ... 16 (flexible)

### Standards and Regulations

Standards/regulations	DIN EN 50178
Rated surge voltage	6 kV
Insulation	Safe isolation, basic insulation, and 4 kV rated surge voltage between all changeover contacts.
Pollution degree	2
Overvoltage category	III

### Environmental Product Compliance

China RoHS	Environmentally Friendly Use Period = 50
	For details about hazardous substances go to tab "Downloads", Category "Manufacturer's declaration"

## Drawings

# Relay Module - RIF-1-RPT-LDP-24DC/2X21 - 2903334

Circuit diagram

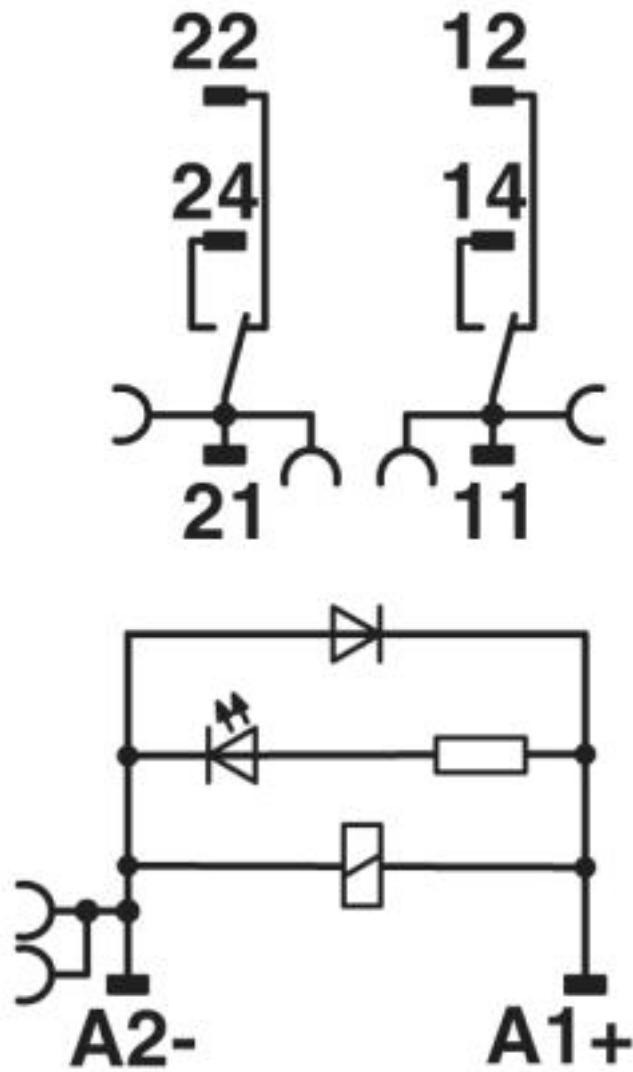

DC coils

# Relay Module - RIF-1-RPT-LDP-24DC/2X21 - 2903334

Diagram

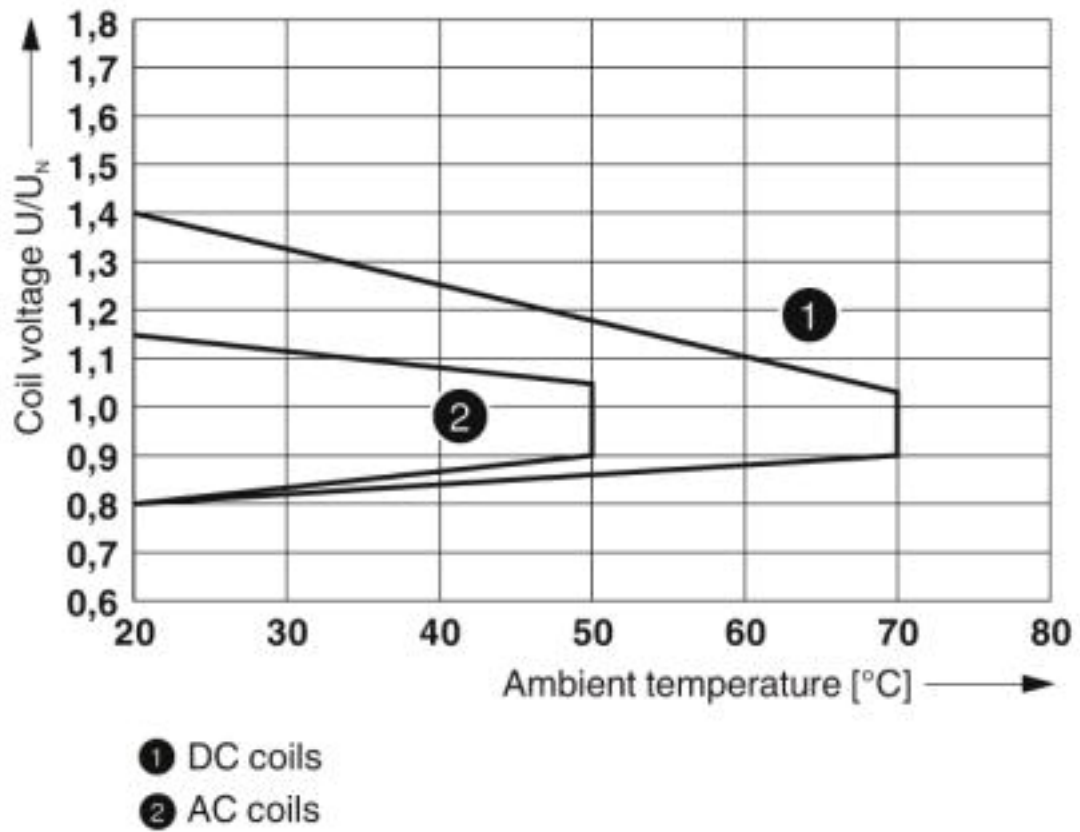

Operating voltage range

# Relay Module - RIF-1-RPT-LDP-24DC/2X21 - 2903334

Diagram

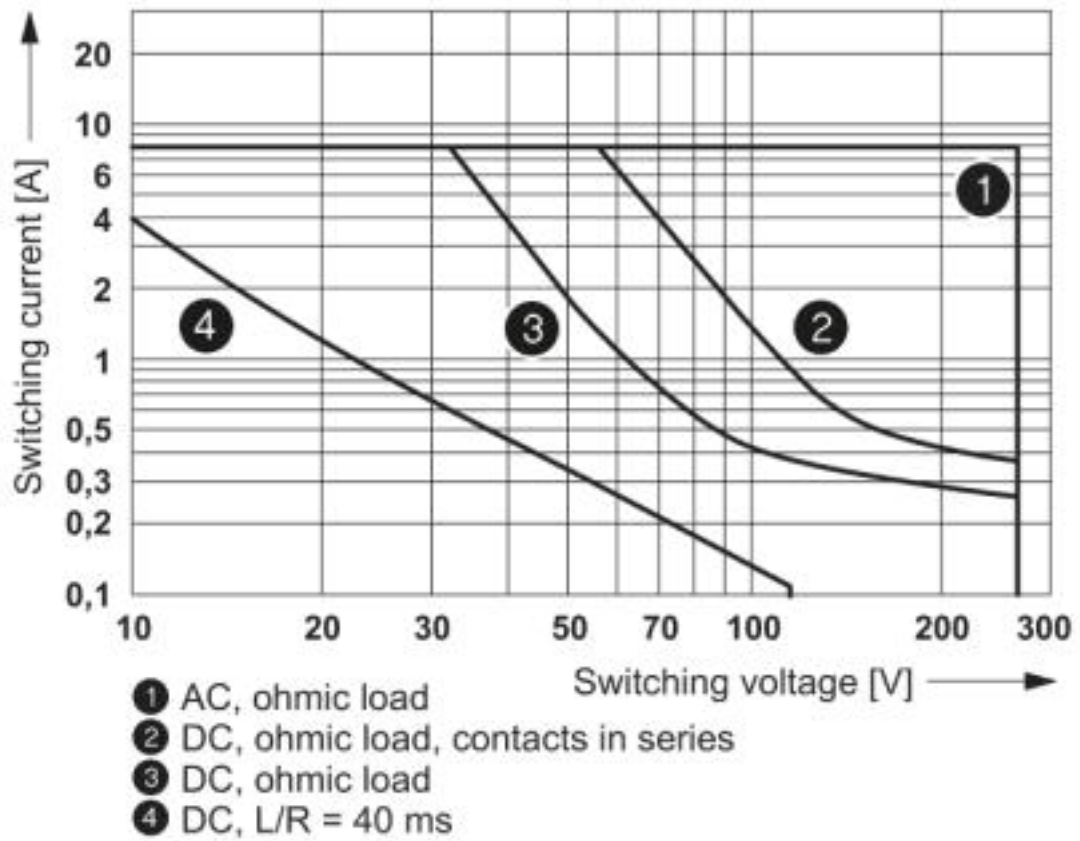

Interrupting rating

# Relay Module - RIF-1-RPT-LDP-24DC/2X21 - 2903334

Diagram

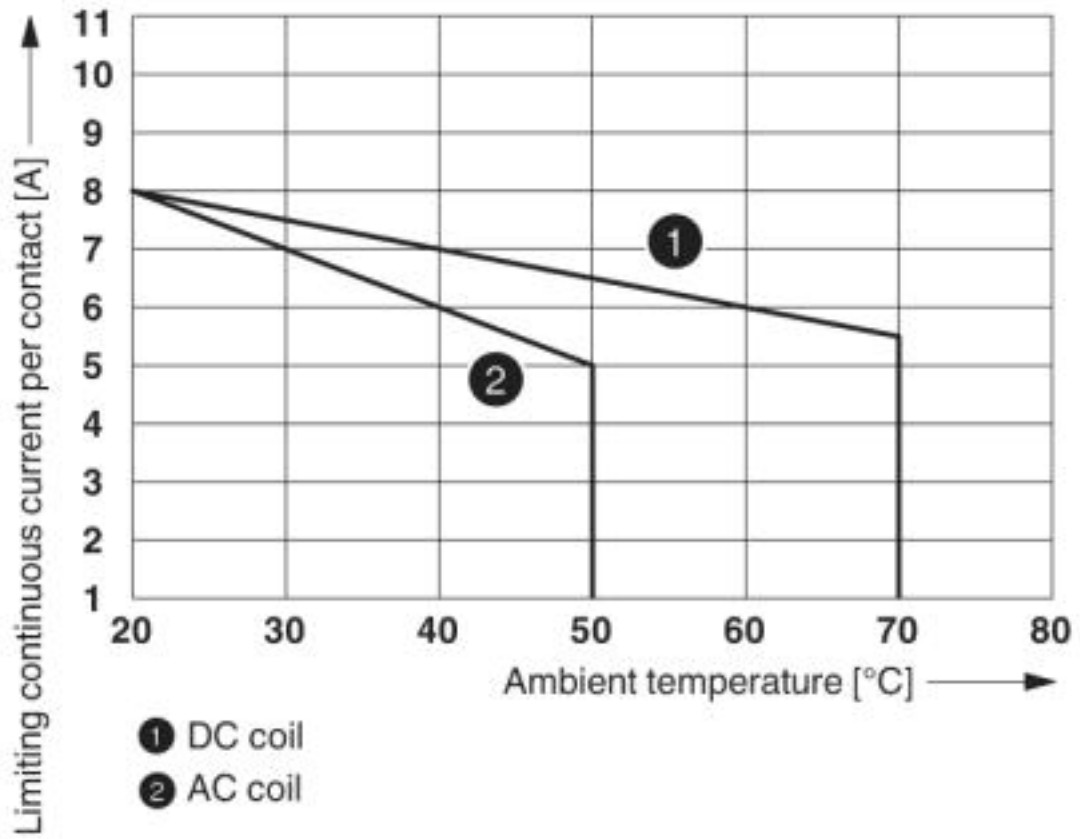

Contact derating

# Relay Module - RIF-1-RPT-LDP-24DC/2X21 - 2903334

Diagram

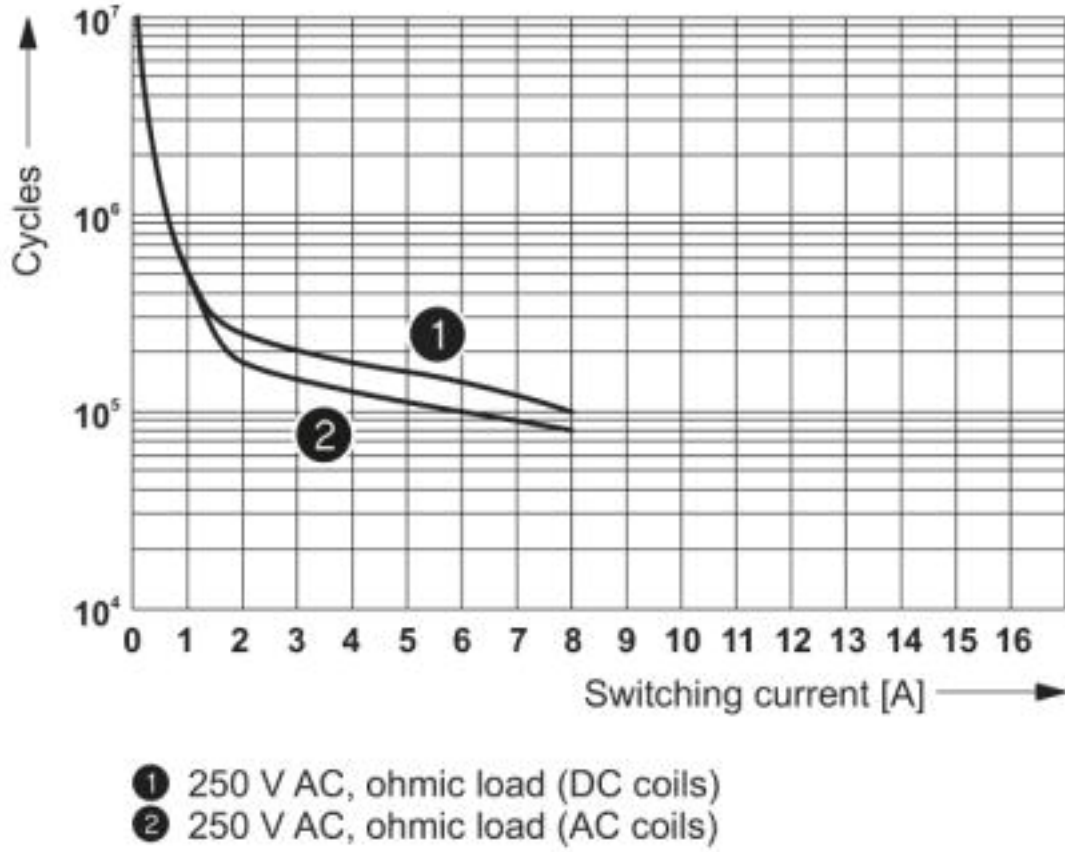

Electrical service life



## Relay Module - RIF-1-RPT-LDP-24DC/2X21 - 2903334

Diagram

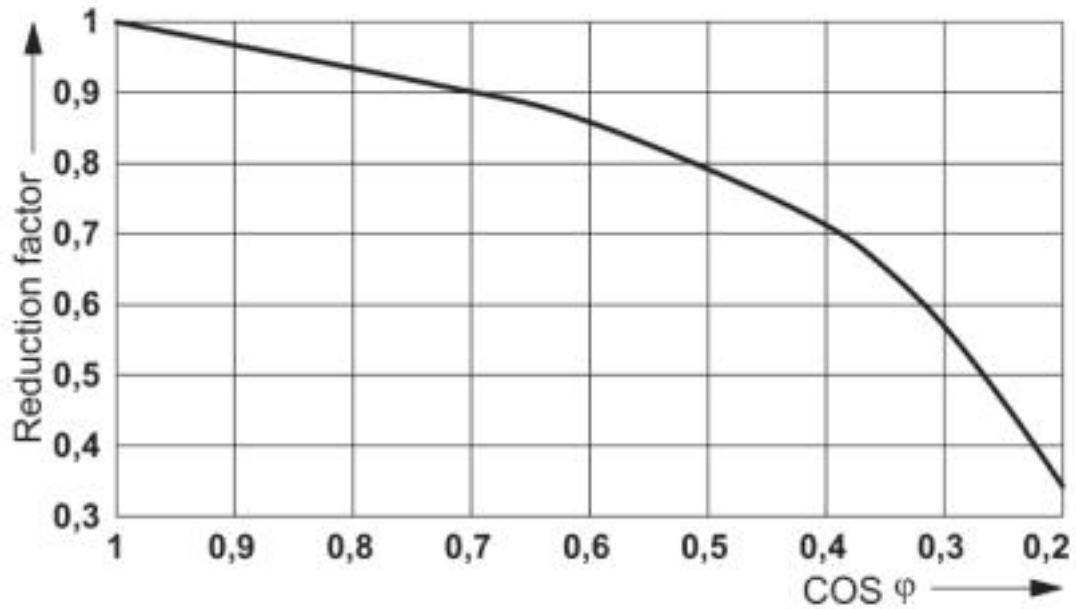

Service life reduction factor

### Articles in set

Relay base - RIF-1-BPT/2X21 - 2900931



RIF-1... relay base, for miniature power relay with 1 or 2 PDTs or solid-state relays of the same design, push-in connection, plug-in option for input/suppressor modules, for mounting on NS 35/7,5

Single relay - REL-MR- 24DC/21-21 - 2961192



Plug-in miniature power relay, with power contact, 2 PDTs, input voltage 24 V DC

Plug-in module - RIF-LDP-12-24 DC - 2900939



Plug-in module, for mounting on RIF-1, RIF-2, RIF-3, and RIF-4, with freewheeling diode and yellow LED, polarity: A1+, A2-, input voltage: 12 ... 24 V DC  $\pm 20\%$

# Relay Module - RIF-1-RPT-LDP-24DC/2X21 - 2903334

## Articles in set

Retaining bracket - RIF-RH-1 - 2900953



Relay retaining bracket, with ejector function and holder for marking material, suitable for RIF-1 relay base, for 16 mm tall miniature power relay and solid-state relay

## Classifications

### eCl@ss

eCl@ss 4.0	27371100
eCl@ss 4.1	27371100
eCl@ss 5.0	27371600
eCl@ss 5.1	27371600
eCl@ss 6.0	27371600
eCl@ss 7.0	27371601
eCl@ss 8.0	27371601
eCl@ss 9.0	27371601

### ETIM

ETIM 2.0	EC001437
ETIM 3.0	EC001437
ETIM 4.0	EC001437
ETIM 5.0	EC001437
ETIM 6.0	EC001437
ETIM 7.0	EC001437

### UNSPSC

UNSPSC 6.01	30211917
UNSPSC 7.0901	39121516
UNSPSC 11	39121516
UNSPSC 12.01	39121516
UNSPSC 13.2	39122334

## Approvals

### Approvals

### Approvals

DNV GL / PRS / LR / EAC





# Relay Module - RIF-1-RPT-LDP-24DC/2X21 - 2903334

## Approvals

Ex Approvals

---

### Approval details

DNV GL		<a href="https://approvalfinder.dnvgl.com/">https://approvalfinder.dnvgl.com/</a>	TAA000018V
PRS		<a href="http://www.prs.pl/">http://www.prs.pl/</a>	TE/2108/880590/16
LR		<a href="http://www.lr.org/en">http://www.lr.org/en</a>	15/20011
EAC			TR_TS_D_00573_c