

MINI MCR-2-RPSS-I-2I-PT - Repeater power supply



2905629

<https://www.phoenixcontact.com/us/products/2905629>

Please be informed that the data shown in this PDF document is generated from our online catalog. Please find the complete data in the user documentation. Our general terms of use for downloads are valid.

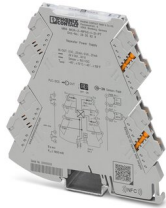

4-way power supply doubler with plug-in connection technology. HART-transparent, 0(4) mA ... 20 mA input signal, 0(4) mA ... 20 mA output signals. The device can be used in both signal and power supply doubler modes. Push-in connection technology.

Product description

The power supply duplicator with plug-in connection technology supplies the transmitter in the field and electrically isolates the input signal transmitted to two loads. HART data protocols can be transmitted bi-directionally via both outputs. You can use the device in signal and power supply duplicator mode with a transmitter supply voltage of $>19.5\text{ V}$. On the output side, the module can be connected to passive input cards. For a maximum load of $\leq 500\ \Omega$ per channel, electrically isolated analog standard signals 0 mA ... 20 mA or 4 mA ... 20 mA are available. The measuring transducer supports fault monitoring and NFC communication.

Commercial data

| | |
|--------------------------------------|--------------------|
| Item number | 2905629 |
| Packing unit | 1 pc |
| Minimum order quantity | 1 pc |
| Sales key | C404 |
| Product key | CK1411 |
| Catalog page | Page 78 (C-5-2019) |
| GTIN | 4046356999441 |
| Weight per piece (including packing) | 120.6 g |
| Weight per piece (excluding packing) | 120 g |
| Customs tariff number | 85437090 |
| Country of origin | DE |

MINI MCR-2-RPSS-I-2I-PT - Repeater power supply



2905629

<https://www.phoenixcontact.com/us/products/2905629>

Technical data

Notes

Utilization restriction

| | |
|----------|---|
| EMC note | EMC: class A product, see manufacturer's declaration in the download area |
|----------|---|

Product properties

| | |
|-----------------|-------------------------|
| Product type | Repeater power supplies |
| Product family | MINI Analog Pro |
| No. of channels | 2 |
| Type | Signal conditioner |
| Configuration | DIP switches |

Insulation characteristics: GB Standard

| | |
|----------------------|----|
| Overvoltage category | II |
| Pollution degree | 2 |

Electrical properties

| | |
|---------------------------------|-------------------------|
| No. of channels | 2 |
| Electrical isolation | 4-way isolation |
| Limit frequency (3 dB) | > 1 kHz |
| Signal transmission behavior | In = Out |
| Step response (10-90%) | < 400 μ s |
| Maximum temperature coefficient | 0.0075 %/K |
| Maximum transmission error | 0.05 % (of final value) |

Electrical isolation Input/output/power supply

| | |
|--------------------------|---|
| Rated insulation voltage | 300 V_{rms} |
| Test voltage | 3 kV AC (50 Hz, 60 s) |
| Insulation | Reinforced insulation according to IEC/EN 61010-1 |

Supply

| | |
|-----------------------------|--|
| Nominal supply voltage | 24 V DC |
| Supply voltage range | 9.6 V DC ... 30 V DC (The DIN rail connector (ME 6,2 TBUS-2 1,5/5-ST-3,81 GN, item no. 2869728) can be used to bridge the supply voltage. It can be snapped onto a 35 mm DIN rail in accordance with EN 60715) |
| Typical current consumption | 40 mA (For 24 V DC and in signal duplicator mode) |
| | 65 mA (For 24 V DC and in power supply duplicator mode) |
| | 75 mA (For 12 V DC and in signal duplicator mode) |
| | 130 mA (For 12 V DC and in power supply duplicator mode) |
| Power consumption | 1.6 W (at $I_{OUT} = 20$ mA, 500 Ω load) |

Input data

MINI MCR-2-RPSS-I-2I-PT - Repeater power supply



2905629

<https://www.phoenixcontact.com/us/products/2905629>

Signal: Current

| | |
|--------------------------------|--|
| Description of the input | Sensor circuit |
| Number of inputs | 1 |
| Current input signal | 0 mA ... 20 mA (Signal duplicator mode) |
| | 4 mA ... 20 mA (Power supply and signal duplicator mode) |
| Input resistance current input | 90 Ω (+1.6 V) |
| Transmitter supply voltage | > 19.5 V |

Output data

Signal: Current

| | |
|---------------------------------|--|
| Number of outputs | 2 |
| Non-load voltage | < 20 V |
| Current output signal | 0 mA ... 20 mA (Signal duplicator mode) |
| | 4 mA ... 20 mA (Power supply and signal duplicator mode) |
| Max. current output signal | 25 mA |
| Load/output load current output | ≤ 500 Ω (per channel) |
| Ripple | < 20 mV _{PP} (500 Ω) |

Connection data

| | |
|----------------------------------|--|
| Connection method | Push-in connection |
| Stripping length | 10 mm |
| Conductor cross section rigid | 0.2 mm ² ... 2.5 mm ² (with ferrule) |
| | 0.14 mm ² ... 2.5 mm ² (without ferrule) |
| Conductor cross section flexible | 0.14 mm ² ... 2.5 mm ² |
| Conductor cross section AWG | 24 ... 12 (flexible) |

Ex data

| | |
|-----------------------|--------|
| Ex installation (EPL) | Gc |
| | Div. 2 |

Interfaces

Data communication (bypass)

| | |
|------------------------|---|
| HART function | Yes |
| Limit frequency (3 dB) | ≈  kHz |

Signaling

| | |
|----------------|----------------------------|
| Status display | Green LED (supply voltage) |
|----------------|----------------------------|

Dimensions

| | |
|--------|-----------|
| Width | 6.2 mm |
| Height | 109.81 mm |
| Depth | 119.2 mm |

MINI MCR-2-RPSS-I-2I-PT - Repeater power supply



2905629

<https://www.phoenixcontact.com/us/products/2905629>

Material specifications

| | |
|--|-------------|
| Fire protection for rail vehicles (DIN EN 45545-2) R22 | HL 1 - HL 2 |
| Fire protection for rail vehicles (DIN EN 45545-2) R23 | HL 1 - HL 2 |
| Fire protection for rail vehicles (DIN EN 45545-2) R24 | HL 1 - HL 2 |
| Housing material | PBT |

Environmental and real-life conditions

Ambient conditions

| | |
|---|-------------------------------|
| Degree of protection | IP20 (not assessed by UL) |
| Ambient temperature (operation) | -40 °C ... 70 °C |
| Ambient temperature (storage/transport) | -40 °C ... 85 °C |
| Altitude | ≤ 2000 m |
| Permissible humidity (operation) | 5 % ... 95 % (non-condensing) |

Approvals

CE

| | |
|-------------|--------------|
| Certificate | CE-compliant |
|-------------|--------------|

ATEX

| | |
|----------------|-----------------------------|
| Identification | ⊕ II 3 G Ex ec ic IIC T4 Gc |
| Certificate | BVS 19 ATEX E 047 X |

UKCA Ex (UKEX)

| | |
|----------------|-----------------------------|
| Identification | ⊕ II 3 G Ex ec ic IIC T4 Gc |
| Certificate | PxCIF21UKEX2902000X |

IECEX

| | |
|----------------|--------------------|
| Identification | Ex ec ic IIC T4 Gc |
| Certificate | IECEX BVS 19.0041X |

CCC / China-Ex

| | |
|----------------|--------------------|
| Identification | Ex nA ic IIC T4 Gc |
|----------------|--------------------|

UL, USA/Canada

| | |
|----------------|---------------------------------------|
| Identification | UL 508 Listed |
| | Class I, Div. 2, Groups A, B, C, D T5 |
| | Class I, Zone 2, Group IIC T5 |

Shipbuilding approval

| | |
|-------------|--------------------------|
| Certificate | DNV GL TAA000021E Rev. 1 |
|-------------|--------------------------|

EAC Ex

| | |
|----------------|---------------------------------|
| Identification | ⊕ II 3 G Ex ec ic IIC T4 Gc |
| Certificate | BY/112 02.01 TP012 103.01 00081 |

DNV GL data

MINI MCR-2-RPSS-I-2I-PT - Repeater power supply



2905629

<https://www.phoenixcontact.com/us/products/2905629>

| | |
|-------------|---|
| Temperature | B |
| Humidity | B |
| Vibration | A |
| EMC | A |
| Enclosure | Required protection according to the Rules shall be provided upon installation on board |

EMC data

| | |
|-------------------------------|--|
| Noise immunity | EN 61000-6-2 |
| Note | When being exposed to interference, there may be minimal deviations. |
| Electromagnetic compatibility | Conformance with EMC directive |
| Noise emission | EN 61000-6-4 |

Electrostatic discharge

| | |
|-----------------------|--------------|
| Standards/regulations | EN 61000-4-2 |
|-----------------------|--------------|

Electrostatic discharge

| | |
|----------|---|
| Comments | Safety measures must be taken to prevent electrostatic discharge. |
|----------|---|

Electromagnetic HF field

| | |
|-----------------------|--------------------------|
| Designation | Electromagnetic RF field |
| Standards/regulations | EN 61000-4-3 |

Fast transients (burst)

| | |
|-----------------------|-------------------------|
| Designation | Fast transients (burst) |
| Standards/regulations | EN 61000-4-4 |

Surge current load (surge)

| | |
|-----------------------|--------------|
| Standards/regulations | EN 61000-4-5 |
|-----------------------|--------------|

Conducted interference

| | |
|-----------------------|-------------------------|
| Designation | Conducted interferences |
| Standards/regulations | EN 61000-4-6 |

Standards and regulations

| | |
|----------------------|-----------------|
| Electrical isolation | 4-way isolation |
|----------------------|-----------------|

GB Standard

| | |
|-----------------------|-----------|
| Standards/regulations | GB 3836.1 |
| | GB 3836.4 |
| | GB 3836.8 |

Mounting

| | |
|-----------------------|---|
| Mounting type | DIN rail mounting |
| Assembly instructions | The DIN rail connector can be used for bridging the supply voltage. It can be snapped onto a 35 mm EN 60715 DIN rail. |
| Mounting position | any |

MINI MCR-2-RPSS-I-2I-PT - Repeater power supply

2905629

<https://www.phoenixcontact.com/us/products/2905629>

Drawings

Block diagram

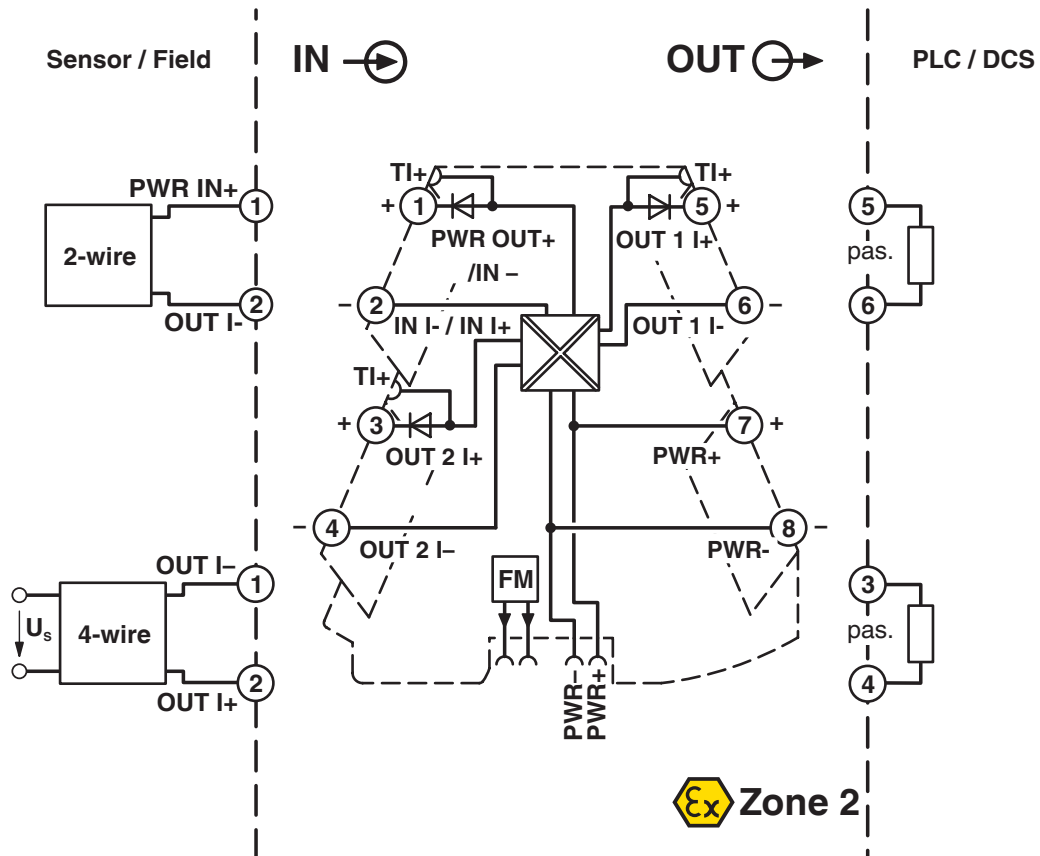

MINI MCR-2-RPSS-I-2I-PT - Repeater power supply



2905629

<https://www.phoenixcontact.com/us/products/2905629>

Approvals

To download certificates, visit the product detail page: <https://www.phoenixcontact.com/us/products/2905629>



EAC

Approval ID: RU*DE.*08.B.01608/19



DNV GL

Approval ID: TAA000021E



UL Listed

Approval ID: FILE E 238705



CCC

Approval ID: 2021322303003858



cUL Listed

Approval ID: FILE E 238705



IECEX

Approval ID: IECEX BVS 19.0041X



cUL Listed

Approval ID: FILE E 196811



UL Listed

Approval ID: FILE E 196811



ATEX

Approval ID: BVS 19 ATEX E 047 X

cULus Listed

cULus Listed

MINI MCR-2-RPSS-I-2I-PT - Repeater power supply



2905629

<https://www.phoenixcontact.com/us/products/2905629>

Classifications

ECLASS

| | |
|-------------|----------|
| ECLASS-11.0 | 27210120 |
| ECLASS-12.0 | 27210120 |
| ECLASS-13.0 | 27210120 |

ETIM

| | |
|----------|----------|
| ETIM 9.0 | EC002653 |
|----------|----------|

UNSPSC

| | |
|-------------|----------|
| UNSPSC 21.0 | 39121000 |
|-------------|----------|

MINI MCR-2-RPSS-I-2I-PT - Repeater power supply



2905629

<https://www.phoenixcontact.com/us/products/2905629>

Environmental product compliance

| | |
|------------|--|
| REACH SVHC | Lead 7439-92-1 |
| China RoHS | Environmentally Friendly Use Period = 50 years |
| | For information on hazardous substances, refer to the manufacturer's declaration available under "Downloads" |

MINI MCR-2-RPSS-I-2I-PT - Repeater power supply



2905629

<https://www.phoenixcontact.com/us/products/2905629>

Accessories

ME 6,2 TBUS-2 1,5/5-ST-3,81 GY - DIN rail bus connectors

2695439

<https://www.phoenixcontact.com/us/products/2695439>

DIN rail connector (TBUS), 5-pos., for bridging the supply voltage, can be snapped onto NS 35/... DIN rail in accordance with EN 60715

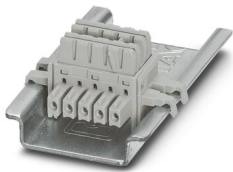

ME 6,2 TBUS-2 1,5/5-ST-3,81 GN - DIN rail bus connectors

2869728

<https://www.phoenixcontact.com/us/products/2869728>

DIN rail connector for DIN rail mounting. Universal for TBUS housing. Gold-plated contacts, 5-pos.

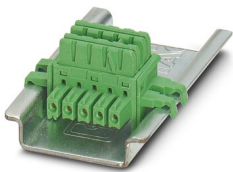

MINI MCR-2-RPSS-I-2I-PT - Repeater power supply

2905629

<https://www.phoenixcontact.com/us/products/2905629>



GW HART USB MODEM - Cable adapter

1003824

<https://www.phoenixcontact.com/us/products/1003824>



USB HART modem cable for communication between a PC and HART devices, cable length: 1m.

TC-D37SUB-AIO16-MP-PS-UNI - Module carrier

2906640

<https://www.phoenixcontact.com/us/products/2906640>

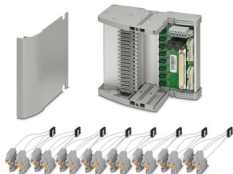

Universal Termination Carrier for connecting 16 MINI Analog Pro signal conditioners to digital or analog I/O cards, via D-SUB connector, 37-pos. (1:1 connection), with HART multiplexer connection

MINI MCR-2-RPSS-I-2I-PT - Repeater power supply

2905629

<https://www.phoenixcontact.com/us/products/2905629>



TC-D37SUB-ADIO16-MP-P-UNI - Module carrier

2906639

<https://www.phoenixcontact.com/us/products/2906639>

Universal Termination Carrier for connecting 16 MINI Analog Pro signal conditioners to digital or analog I/O cards, via D-SUB connector, 37-pos. (1:1 connection)



MINI MCR-2-V8-FLK 16 - System adapter

2901993

<https://www.phoenixcontact.com/us/products/2901993>

Eight MINI Analog Pro signal conditioners and measuring transducers can be connected to a controller with minimal cabling effort and without any errors using system adapters and system cabling.



MINI MCR-2-RPSS-I-2I-PT - Repeater power supply

2905629

<https://www.phoenixcontact.com/us/products/2905629>



MINI MCR-2-V8-MOD-RTU - Communication module

2905634

<https://www.phoenixcontact.com/us/products/2905634>

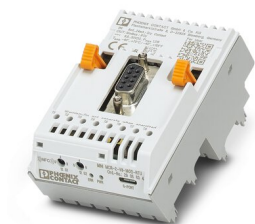

Eight MINI Analog Pro signal conditioners and measuring transducers are quickly and easily integrated into a Modbus/RTU network via a communication adapter.

MINI MCR-2-V8-MOD-TCP - Communication module

2905635

<https://www.phoenixcontact.com/us/products/2905635>



Eight MINI Analog Pro signal conditioners and measuring transducers are quickly and easily integrated into a Modbus/TCP network via a communication adapter.

MINI MCR-2-RPSS-I-2I-PT - Repeater power supply

2905629

<https://www.phoenixcontact.com/us/products/2905629>



MINI MCR-2-V8-PB-DP - Communication module

2905636

<https://www.phoenixcontact.com/us/products/2905636>



Eight MINI Analog Pro signal conditioners and measuring transducers are quickly and easily integrated into a PROFIBUS DP network via a communication adapter.

MINI MCR-2-V8-PN - Communication module

2905637

<https://www.phoenixcontact.com/us/products/2905637>



Eight MINI Analog Pro signal conditioners and measuring transducers can be quickly and easily integrated into a PROFINET network via a communication adapter.

MINI MCR-2-RPSS-I-2I-PT - Repeater power supply



2905629

<https://www.phoenixcontact.com/us/products/2905629>

FASTCON PRO-SET - Connector set

2906227

<https://www.phoenixcontact.com/us/products/2906227>



FASTCON Pro plug set consisting of four plugs with screw connection, one for each position on the module. Suitable for all MINI Analog Pro modules.

FASTCON PRO-SET-PT - Connector set

2906228

<https://www.phoenixcontact.com/us/products/2906228>



FASTCON Pro plug set consisting of four plugs with push-in connection, one for each position on the module. Suitable for all MINI Analog Pro modules.

MINI MCR-2-RPSS-I-2I-PT - Repeater power supply



2905629

<https://www.phoenixcontact.com/us/products/2905629>

UCT-EM (30X5) - Marker for end clamp

0801505

<https://www.phoenixcontact.com/us/products/0801505>



Marker for end clamp, Sheet, white, unlabeled, can be labeled with: TOPMARK NEO, TOPMARK LASER, BLUEMARK ID COLOR, BLUEMARK ID, BLUEMARK CLED, THERMOMARK PRIME, THERMOMARK CARD 2.0, THERMOMARK CARD, mounting type: snapped, lettering field size: 30 x 5 mm, Number of individual labels: 24

UCT-EM (30X5) CUS - Marker for end clamp

0801589

<https://www.phoenixcontact.com/us/products/0801589>



Marker for end clamp, can be ordered: by sheet, white, labeled according to customer specifications, mounting type: snapped into marker carrier, lettering field size: 30 x 5 mm, Number of individual labels: 24

MINI MCR-2-RPSS-I-2I-PT - Repeater power supply



2905629

<https://www.phoenixcontact.com/us/products/2905629>

SK 5,0 WH:REEL - Marker strip

0805221

<https://www.phoenixcontact.com/us/products/0805221>



Marker strip, Roll, white, unlabeled, can be labeled with: THERMOMARK E.300 (D)/600 (D), THERMOMARK ROLL 2.0, THERMOMARK ROLL, THERMOMARK ROLL X1, THERMOMARK ROLLMASTER 300/600, THERMOMARK X1.2, mounting type: adhesive, lettering field size: continuous x 5 mm, Number of individual labels: 10

UC-EMLP (15X5) - Plastic label

0819301

<https://www.phoenixcontact.com/us/products/0819301>



Plastic label, Sheet, white, unlabeled, can be labeled with: BLUEMARK ID COLOR, BLUEMARK ID, BLUEMARK CLED, PLOTMARK, CMS-P1-PLOTTER, mounting type: adhesive, lettering field size: 15 x 5 mm, Number of individual labels: 10

MINI MCR-2-RPSS-I-2I-PT - Repeater power supply



2905629

<https://www.phoenixcontact.com/us/products/2905629>

UC-EMLP (15X5) YE - Plastic label

0822615

<https://www.phoenixcontact.com/us/products/0822615>

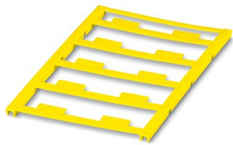

Plastic label, Sheet, yellow, unlabeled, can be labeled with: BLUEMARK ID COLOR, BLUEMARK ID, BLUEMARK CLED, PLOTMARK, CMS-P1-PLOTTER, mounting type: adhesive, lettering field size: 15 x 5 mm, Number of individual labels: 10

UC-EMLP (15X5) CUS - Plastic label

0824550

<https://www.phoenixcontact.com/us/products/0824550>



Plastic label, can be ordered: by sheet, white, labeled according to customer specifications, mounting type: adhesive, lettering field size: 15 x 5 mm

MINI MCR-2-RPSS-I-2I-PT - Repeater power supply

2905629

<https://www.phoenixcontact.com/us/products/2905629>



UC-EMLP (15X5) YE CUS - Plastic label

0824551

<https://www.phoenixcontact.com/us/products/0824551>

Plastic label, can be ordered: by sheet, yellow, labeled according to customer specifications, mounting type: adhesive, lettering field size: 15 x 5 mm

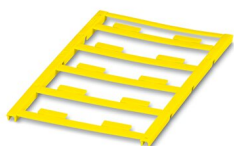

UC-EMLP (15X5) SR - Plastic label

0828095

<https://www.phoenixcontact.com/us/products/0828095>

Plastic label, Sheet, silver, unlabeled, can be labeled with: BLUEMARK ID COLOR, BLUEMARK ID, BLUEMARK CLED, PLOTMARK, CMS-P1-PLOTTER, mounting type: adhesive, lettering field size: 15 x 5 mm, Number of individual labels: 10

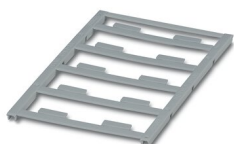

MINI MCR-2-RPSS-I-2I-PT - Repeater power supply



2905629

<https://www.phoenixcontact.com/us/products/2905629>

UC-EMLP (15X5) SR CUS - Plastic label

0828099

<https://www.phoenixcontact.com/us/products/0828099>



Plastic label, can be ordered: by sheet, silver, labeled according to customer specifications, mounting type: adhesive, lettering field size: 15 x 5 mm, Number of individual labels: 10

US-EMLP (15X5) - Plastic label

0828790

<https://www.phoenixcontact.com/us/products/0828790>



Plastic label, Card, white, unlabeled, can be labeled with: BLUEMARK ID COLOR, BLUEMARK ID, THERMOMARK PRIME, THERMOMARK CARD 2.0, THERMOMARK CARD, mounting type: adhesive, lettering field size: 15 x 5 mm, Number of individual labels: 189

MINI MCR-2-RPSS-I-2I-PT - Repeater power supply



2905629

<https://www.phoenixcontact.com/us/products/2905629>

US-EMLP (15X5) YE - Plastic label

0828873

<https://www.phoenixcontact.com/us/products/0828873>



Plastic label, Card, yellow, unlabeled, can be labeled with: BLUEMARK ID COLOR, BLUEMARK ID, THERMOMARK PRIME, THERMOMARK CARD 2.0, THERMOMARK CARD, mounting type: adhesive, lettering field size: 15 x 5 mm, Number of individual labels: 189

US-EMLP (15X5) SR - Plastic label

0828874

<https://www.phoenixcontact.com/us/products/0828874>



Plastic label, Card, silver, unlabeled, can be labeled with: BLUEMARK ID COLOR, BLUEMARK ID, THERMOMARK PRIME, THERMOMARK CARD 2.0, THERMOMARK CARD, mounting type: adhesive, lettering field size: 15 x 5 mm, Number of individual labels: 189

MINI MCR-2-RPSS-I-2I-PT - Repeater power supply



2905629

<https://www.phoenixcontact.com/us/products/2905629>

US-EMLP (15X5) CUS - Plastic label

0830076

<https://www.phoenixcontact.com/us/products/0830076>

Plastic label, can be ordered: by card, white, labeled according to customer specifications, mounting type: adhesive, lettering field size: 15 x 5 mm, Number of individual labels: 189



US-EMLP (15X5) YE CUS - Plastic label

0830077

<https://www.phoenixcontact.com/us/products/0830077>

Plastic label, can be ordered: by card, yellow, labeled according to customer specifications, mounting type: adhesive, lettering field size: 15 x 5 mm, Number of individual labels: 189



MINI MCR-2-RPSS-I-2I-PT - Repeater power supply

2905629

<https://www.phoenixcontact.com/us/products/2905629>



US-EMLP (15X5) SR CUS - Plastic label

0830078

<https://www.phoenixcontact.com/us/products/0830078>

Plastic label, can be ordered: by card, silver, labeled according to customer specifications, mounting type: adhesive, lettering field size: 15 x 5 mm, Number of individual labels: 189



UCT-EM (30X5) YE - Marker for end clamp

0830340

<https://www.phoenixcontact.com/us/products/0830340>

Marker for end clamp, Sheet, yellow, unlabeled, can be labeled with: TOPMARK NEO, TOPMARK LASER, BLUEMARK ID COLOR, BLUEMARK ID, BLUEMARK CLED, THERMOMARK PRIME, THERMOMARK CARD 2.0, THERMOMARK CARD, mounting type: snapped, lettering field size: 30 x 5 mm, Number of individual labels: 24



MINI MCR-2-RPSS-I-2I-PT - Repeater power supply

2905629

<https://www.phoenixcontact.com/us/products/2905629>



UCT-EM (30X5) YE CUS - Marker for end clamp

0830348

<https://www.phoenixcontact.com/us/products/0830348>

Marker for end clamp, can be ordered: by sheet, yellow, labeled according to customer specifications, mounting type: snapped into marker carrier, lettering field size: 30 x 5 mm, Number of individual labels: 24



MINI MCR-2-PTB - Power terminal block

2902066

<https://www.phoenixcontact.com/us/products/2902066>

Power terminal with plug-in connection technology for delivering the supply voltage to the DIN rail connector. Monitoring of the supply voltages in combination with the fault monitoring module. Screw connection technology



MINI MCR-2-RPSS-I-2I-PT - Repeater power supply

2905629

<https://www.phoenixcontact.com/us/products/2905629>



MINI MCR-2-PTB-PT - Power terminal block

2902067

<https://www.phoenixcontact.com/us/products/2902067>



Power terminal with plug-in connection technology for delivering the supply voltage to the DIN rail connector. Monitoring of the supply voltages in combination with the fault monitoring module. Push-in connection technology

QUINT4-SYS-PS/1AC/24DC/2.5/SC - Power supply unit

2904614

<https://www.phoenixcontact.com/us/products/2904614>



Primary-switched power supply, QUINT POWER, screw connection, DIN rail mounting, supply of devices possible via the TBUS DIN rail connector, protective coating, input: single-phase, output: 24 V DC/2.5 A

MINI MCR-2-RPSS-I-2I-PT - Repeater power supply

2905629

<https://www.phoenixcontact.com/us/products/2905629>



MINI MCR-2-FM-RC - Monitoring block

2904504

<https://www.phoenixcontact.com/us/products/2904504>



Fault monitoring module with plug-in connection technology for evaluating and reporting group errors from the FM system and for monitoring the supply voltages. Error message via N/C contact. Screw connection technology, standard configuration

MINI MCR-2-FM-RC-PT - Monitoring block

2904508

<https://www.phoenixcontact.com/us/products/2904508>



Fault monitoring module with plug-in connection technology for evaluating and reporting group errors from the FM system and for monitoring the supply voltages. Error message via N/C contact. Push-in connection technology, standard configuration

MINI MCR-2-RPSS-I-2I-PT - Repeater power supply

2905629

<https://www.phoenixcontact.com/us/products/2905629>



SZS 0,6X3,5 - Screwdriver

1205053

<https://www.phoenixcontact.com/us/products/1205053>



Actuation tool, for ST terminal blocks, insulated, also suitable for use as a bladed screwdriver, size: 0.6 x 3.5 x 100 mm, 2-component grip, with non-slip grip

Phoenix Contact 2023 © - all rights reserved

<https://www.phoenixcontact.com>

Phoenix Contact USA
586 Fulling Mill Road
Middletown, PA 17057, United States
(+717) 944-1300
info@phoenixcon.com