

Relay Module - PLC-RSC-120UC/21-21 - 2967086

Please be informed that the data shown in this PDF Document is generated from our Online Catalog. Please find the complete data in the user's documentation. Our General Terms of Use for Downloads are valid (<http://phoenixcontact.com/download>)



PLC relay, consisting of base terminal block PLC-BSC.../21 with screw connection and pluggable miniature relay with power contact, for assembly on DIN rail NS 35/7.5, 2 PDT, input voltage 120 V AC / 110 V DC

Your advantages

- Slim design
- Efficient connection to system cabling using V8 adapter
- RT III sealed relay
- Safe isolation according to DIN EN 50178 between coil and contact
- Integrated input circuit and interference suppression circuit
- Functional plug-in bridges



Key Commercial Data

Packing unit	10 pc
GTIN	
GTIN	4017918156398
Sales Key	08

Technical data

Note

Utilization restriction	EMC: class A product, see manufacturer's declaration in the download area
-------------------------	---

Dimensions

Width	14 mm
Height	80 mm
Depth	94 mm

Ambient conditions

Ambient temperature (operation)	-40 °C ... 60 °C
Ambient temperature (storage/transport)	-40 °C ... 85 °C

Relay Module - PLC-RSC-120UC/21-21 - 2967086

Technical data

Ambient conditions

Degree of protection	RT III (Relay)
	IP20 (Relay base)

Coil side

Nominal input voltage U_N	120 V AC
	110 V DC
Typical input current at U_N	4.5 mA (at $U_N = 120$ V AC)
	4.2 mA (at $U_N = 110$ V DC)
Typical response time	7 ms
Typical release time	10 ms
Protective circuit	Bridge rectifier Bridge rectifier
Operating voltage display	Yellow LED
Power dissipation for nominal condition	0.54 W

Contact side

Contact type	2 PDT
Type of switch contact	Single contact
Contact material	AgNi
Maximum switching voltage	250 V AC/DC (The separating plate PLC-ATP should be installed for voltages larger than 250 V (L1, L2, L3) between identical terminal blocks in adjacent modules. Potential bridging is then carried out with FBST 8-PLC... or ...FBST 500...)
Minimum switching voltage	5 V AC/DC (at 10 mA)
Min. switching current	10 mA (At 5 V)
Maximum inrush current	15 A (300 ms)
Limiting continuous current	6 A
Interrupting rating (ohmic load) max.	140 W (at 24 V DC)
	85 W (at 48 V DC)
	60 W (at 60 V DC)
	44 W (at 110 V DC)
	60 W (at 220 V DC)
	1500 VA (for 250 V AC)
Switching capacity	2 A (at 24 V, DC13)
	3 A (at 24 V, AC15)
	3 A (at 120 V, AC15)
	0.2 A (at 250 V, DC13)
	3 A (at 250 V, AC15)

Connection data

Connection name	Coil side
Connection method	Screw connection
Stripping length	8 mm
Screw thread	M3

Relay Module - PLC-RSC-120UC/21-21 - 2967086

Technical data

Connection data

Conductor cross section solid	0.14 mm ² ... 2.5 mm ²
Conductor cross section flexible	0.14 mm ² ... 2.5 mm ²
	0.2 mm ² ... 2.5 mm ² (Single ferrule)
	2x 0.5 mm ² ... 1.5 mm ² (TWIN ferrule)
Conductor cross section AWG	26 ... 14

Connection data 2

Connection name	Contact side
Connection method	Screw connection
Stripping length	8 mm
Screw thread	M3
Conductor cross section solid	0.14 mm ² ... 2.5 mm ²
Conductor cross section flexible	0.14 mm ² ... 2.5 mm ²
	0.2 mm ² ... 2.5 mm ² (Single ferrule)
	2x 0.5 mm ² ... 1.5 mm ² (TWIN ferrule)
Conductor cross section AWG	26 ... 14

General

Test voltage relay winding/relay contact	4 kV AC (50 Hz, 1 min.)
Test voltage PDT/PDT	2.5 kV AC (50 Hz, 1 min.)
Operating mode	100% operating factor
Degree of protection	RT III (Relay)
	IP20 (Relay base)
Mechanical service life	3x 10 ⁷ cycles
Mounting position	any
Assembly instructions	In rows with zero spacing

Standards and Regulations

Connection in acc. with standard	CUL
Designation	Standards/regulations
Standards/regulations	IEC 60664
	EN 50178
Rated surge voltage	6 kV
Insulation	Safe isolation: Control side / contact side
Degree of pollution	2
Overvoltage category	III
Flammability rating according to UL 94	V0

Environmental Product Compliance

REACH SVHC	Lead 7439-92-1
China RoHS	Environmentally Friendly Use Period = 50

Relay Module - PLC-RSC-120UC/21-21 - 2967086

Technical data

Environmental Product Compliance

	For details about hazardous substances go to tab "Downloads", Category "Manufacturer's declaration"
--	---

Drawings

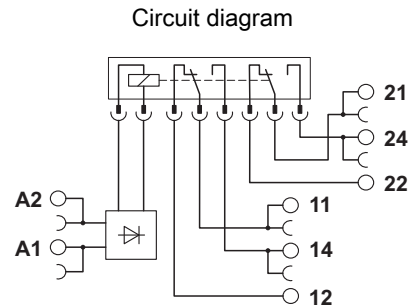
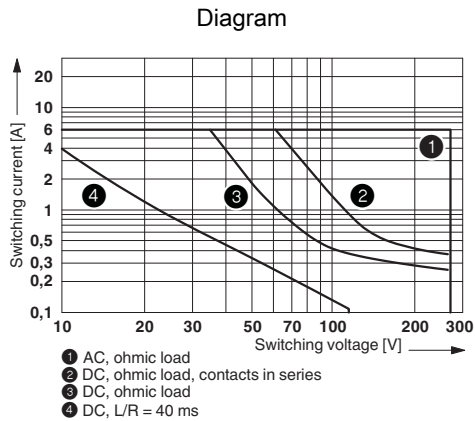

Interrupting rating

Diagram

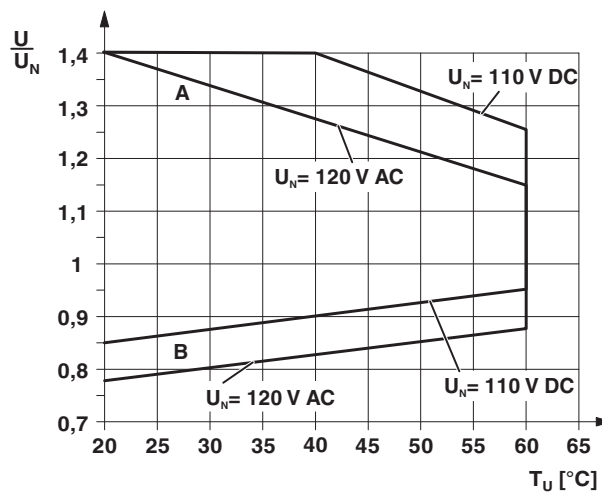

Curve A

Maximum permissible continuous voltage U_{max} with limiting continuous current on the contact side (see relevant technical data)

Curve B

Minimum permissible operate voltage U_{op} after pre-excitation (see relevant technical data)

Relay Module - PLC-RSC-120UC/21-21 - 2967086

Articles in set

Relay base - PLC-BSC-120UC/21-21 - 2967031



14 mm PLC basic terminal block with screw connection, without relay or solid-state relay, for mounting on DIN rail NS 35/7,5, 2 PDTs, input voltage 120 V AC/DC

Single relay - REL-MR-110DC/21-21 - 2961202



Plug-in miniature power relay, with power contact, 2 PDTs, input voltage 110 V DC

Approvals

Approvals

Approvals

PRS / UL Listed / UL Recognized / cUL Recognized / cUL Listed / EAC / RC FRT / DNV GL / cULus Recognized / cULus Listed

Ex Approvals

Approval details

PRS		http://www.prs.pl/	TE/2109/880590/16
-----	--	---	-------------------







UL Listed		http://database.ul.com/cgi-bin/XYV/template/LISEXT/1FRAME/index.htm	FILE E 172140
-----------	--	---	---------------

UL Recognized		http://database.ul.com/cgi-bin/XYV/template/LISEXT/1FRAME/index.htm	FILE E 238705
---------------	--	---	---------------

cUL Recognized		http://database.ul.com/cgi-bin/XYV/template/LISEXT/1FRAME/index.htm	FILE E 238705
----------------	--	---	---------------

Relay Module - PLC-RSC-120UC/21-21 - 2967086

Approvals

cUL Listed		http://database.ul.com/cgi-bin/XYV/template/LISEXT/1FRAME/index.htm	FILE E 172140
EAC			RU C- DE.A*30.B.01082
RC FRT			B.00094
DNV GL		https://approvalfinder.dnvgl.com/	TAE0000196-02
cULus Recognized			
cULus Listed			

Phoenix Contact 2019 © - all rights reserved
<http://www.phoenixcontact.com>

PHOENIX CONTACT GmbH & Co. KG
Flachsmarktstr. 8
32825 Blomberg
Germany
Tel. +49 5235 300
Fax +49 5235 3 41200
<http://www.phoenixcontact.com>