

# SpaceLogic Sensors

## Humidity Sensors – Analog and Temperature Sensors – Analog



Note: A subset of models shown.

### Product Description

The SpaceLogic SLA Series of humidity and temperature sensors for living space is a flexible multisensor platform for use with BAS controllers designed to accept 4 to 20mA, 0 to 5Vdc or 0 to 10Vdc outputs. Housings are available in Medium matte white and Optimum faces available in black and white. All housing types are available with three user interface options: touchscreen, LCD with three buttons and blank. Temperature sensors are included with all SLA Series humidity sensors.

### Features

- Medium matte white housing or optimum glass panel housing available in white or black
- Humidity versions feature a replaceable RH element available in 1% & 2% with NIST certificate
- Temperature output on all models
- 61 mm (2.4") backlit color touchscreen and LCD, three button display options available
  - Digital temperature indication (0.1° display resolution of °F or °C)
  - Digital humidity indication (0.1% RH display resolution)
  - Selectable temp, RH and fan speed setpoint (0-10V)
  - Configurable screen/button lock and display timeout
  - Override
- Selectable 4 to 20mA, 0 to 5V and 0 to 10V analog outputs
- 18-24 AWG screw terminals

### Available Products Matrix

SLA	<input type="checkbox"/>		<input type="checkbox"/>	X	<input type="checkbox"/>	
	S = Medium white matte housing		T = Color touchscreen		2 = 2% RH** and temp.	Example: SLA <input type="checkbox"/> <input type="checkbox"/> <input type="checkbox"/> <input type="checkbox"/> <input type="checkbox"/>
	W = Optimum white housing		L = 3-button LCD display		X = Temperature only	
	B = Optimum black housing		X = None			

\*Replaceable RH module available to be ordered separately per table below.

### Replaceable RH Elements

Model	RH Accuracy	Calibration Certificate	Description
SLXRHS1N	±1%	X	Replaceable RH Sensor, 1% w/NIST Cert
SLXRHS2N	±2%	X	Replaceable RH Sensor, 2% w/NIST Cert
SLXRHS2X	±2%		Replaceable RH Sensor, 2%

USA: +1 888-444-1311  
 Europe: +46 10 478 2000  
 Asia: +65 6484 7877  
 www.schneider-electric.com

Life Is On



## Specifications

Operating Environment	
Input power	Class 2; 20 to 30 Vdc, 24 Vac, 50 to 60 Hz
Analog output	Selectable 4 to 20 mA, 0 to 5 V, 0 to 10 V
Operating temp. range	0 to 50 °C (32 to 122 °F)
Operating humidity range	0 to 95% RH non-condensing
Housing material	High impact ABS plastic
IP rating	IP 30
Mounting location	For indoor use only. Not suitable for wet locations.
Surface mount	The device can be surface mounted on Single Gang J-Box, British Standard and CE60 wall boxes
RH Sensor Option	
HS sensor	Thin-film capacitive, replaceable
Accuracy	±2% from 10 to 80% RH @ 25°C (77 °F)
Hysteresis	1.5% typical
Linearity	Included in accuracy specification
Stability	±1% @ 20°C (68 °F) annually for 2 years
Output range	0 to 100% RH
Temperature coefficient	±0.1% RH/°C above or below 25 °C (77 °F) typical
Temperature Sensor	
Sensor type	Solid state, integrated circuit
Accuracy	±0.2 °C (±0.4 °F) typical
Resolution	0.1 °C (0.1 °F)
Range	0 to 50 °C (32 to 122 °F)
Display Models	
Touchscreen	61 mm (2.4 in), color, backlit, capacitive, 240x300px Setpoint: 0-10Vdc. Temperature, humidity*** or fan speed selectable* Timeout override: Display timeout* Lockout override: Touchscreen/button lockout*
LCD	52mm (2.05 in), segmented with 3 buttons Setpoint: 0-10Vdc. Temperature, humidity*** or fan speed selectable Timeout override: Display timeout* Lockout override: Touchscreen/button lockout*
Setpoints**	
Temperature setpoint	0 to 10V output Scale: 10 to 35 °C (50 to 95 °F) / 0 to 50 °C (32 to 122 °F)
Humidity setpoint	0 to 10V output Scale: 0 to 100% RH
Fan speed setpoint	0 to 10V output Off 0V, Auto 1.5V, Low 3.3V, Med. 6.7V, High 10.0V
Override	
Override button	Display models feature a momentary-to-ground override button

## Wiring Terminals

Terminal blocks	Screw terminals, 18-24 AWG
Screw terminal torque	0.2 N-m (2.0 in-lbF) max.

## Regulatory Information

Agency approvals	UL 916, European conformance CE: EN61000-6-2 EN61000-6-3 EN61000 Series - industrial immunity EN 61326-1 FCC Part 15 Class B, REACH, RoHS, Green Premium, RCM (Australia), ICES-003 (Canada), EAC (Russia)
------------------	---

\* DIP switch selectable.

\*\* One setpoint type is selectable via DIP switch on display models only.

\*\*\* Does not appear on temperature-only models.

## Dimensions mm (in.)

### Optimum Housing

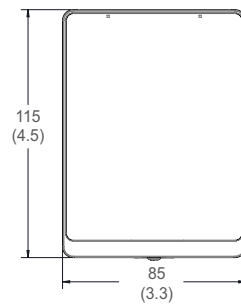

### Medium Housing

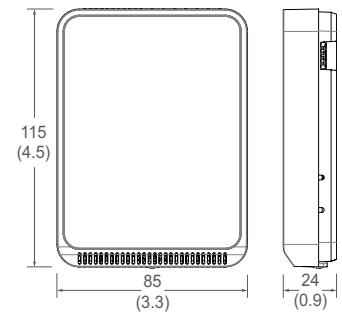

## Base Hole Measurement

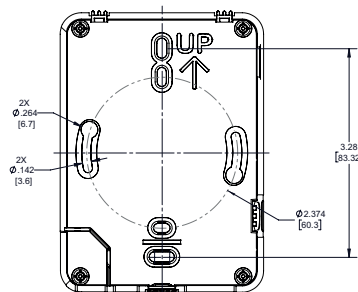

### Installation

1. Remove the cover from the base at the bottom of the device.



2. Position the sensor base vertically on the wall 1.35 m (4.5 ft.) above the floor with the “UP” arrow facing upward. Locate away from windows, vents and other sources of draft. If possible, do not mount on an external wall, as this may cause inaccurate temperature readings.



3. Pull 18 or 22 AWG cable(s) through the hole in the backplate.

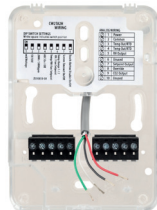

4. Mount the backplate onto the wall using the screws provided.

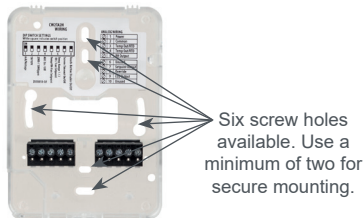

5. Connect the wires to the screw terminals. Do not over-tighten the screws.

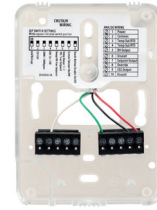

Wiring for models with RH and Temperature:

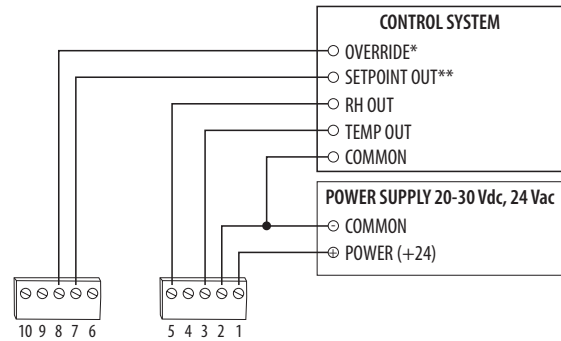

\* Momentary to ground.

\*\* 0-10V DIP switch selectable for temperature, RH (if equipped) or fan speed (Off 0V, Auto 1.5V, Low 3.3V, Medium 6.7V or high 10V).

Wiring for models with LCD and Temperature transmitter only (SLASLXX, SLABLXX and SLAWLXX):

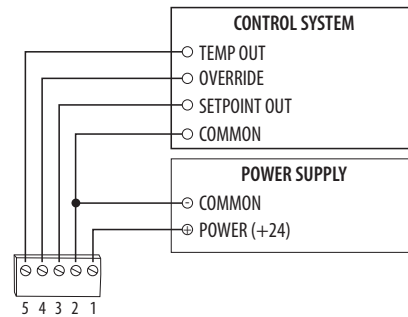

### Installation (cont.)

Set the DIP switches.

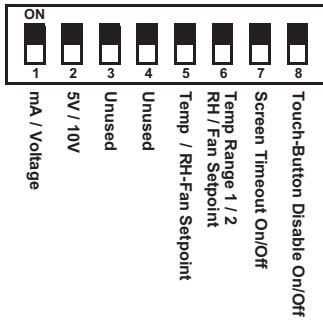

Switch	Function	Description
1	Output mode	ON - 4-20mA output mode enabled OFF - Voltage output mode enabled
2	Voltage output range*	ON - 0-5V output range enabled OFF 0-10V output range enabled
3	Unused	Unused
4	Unused	Unused
5	Setpoint output type	ON - Temperature setpoint enabled (temp range selected on DIP switch 6) OFF** - RH or Fan Speed setpoint enabled (specific setpoint output type to be selected on DIP switch 6) Models without RH option select only temp or fan setpoint
6	Setpoint output temperature range or RH/Fan Speed output type	Temperature setpoint (must be enabled on DIP switch 5) ON - Temp range 1, 50 to 95 °F (10 to 35 °C) enabled OFF - Temp range 2, 32 to 122 °F (0 to 50 °C) enabled  RH or Fan Speed setpoint (must be enabled on DIP switch 5)*** ON - RH setpoint enabled OFF - Fan Speed setpoint enabled Models without RH option, set to OFF
7	Display times out and turns off after 6-10 seconds of touchscreen/button press	ON - Display Timeout enabled OFF - Display Timeout disabled
8	Touchscreen touch functions and buttons are disabled	ON - Touchscreen touch/button functions disabled OFF - Touchscreen touch/button functions enabled

\* Only used with voltage output mode enabled. Not applicable to setpoint output. Setpoint is 0-10V fixed.

\*\* Models without RH: OFF is for fan setpoint type.

\*\*\* No selection needed on non-RH models.

- With sensor base fully installed, align top of cover to mounting tabs on top of sensor base. Swing cover downward until it latches at the bottom.



- Install locking screw to secure cover in closed position.



### Touchscreen Operation Main Screen

The touchscreen user interface displays applicable sensor output values (temperature and RH), setpoint value and menu button.

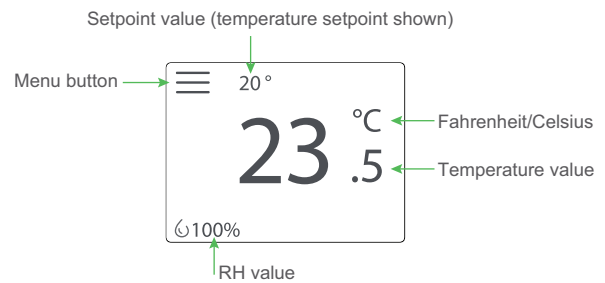

### Menu Screen

The menu screen opens when pressing the Menu button on the main screen. Integrator's submenu, occupancy/override, Fahrenheit/Celsius, settings and setpoint submenu (temp, RH or fan, determined by DIP switch settings) are displayed on the menu screen.

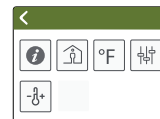

Temperature setpoint  
DIP switch selected

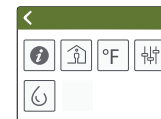

RH setpoint\*  
DIP switch selected

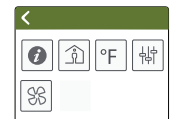

Fan Speed setpoint  
DIP switch selected

\* Does not appear on temperature-only models.

## Menu Button Functions

 **Integrator's Submenu**  
Press this icon to access the Integrator's menu.

Submenu Only

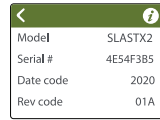

 **Occupied Override Button**  
Press this icon to provide momentary ground output to the controller

Single Press Only

 Signals occupied/override call to controller.

 **Fahrenheit/Celsius Switch**  
Press this icon to display either °C or °F.

Single Press Only

 Changes units to Fahrenheit when pressed.

 Changes units to Celsius when pressed.

 **Settings**  
This icon provides the ability to change the color scheme of the display.

Submenu Only

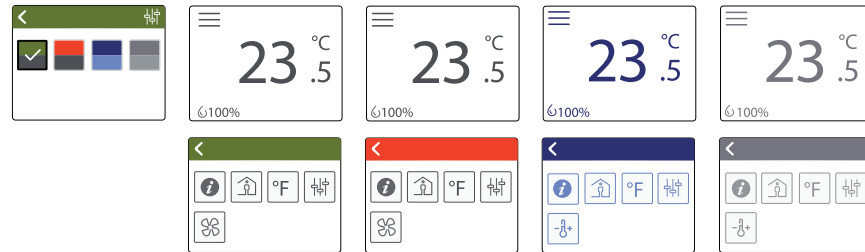

 **Temp Setpoint Adjustment**  
Click this icon to access the setpoint change menu. Mutually exclusive with fan speed, set by DIP switch.

Submenu Only

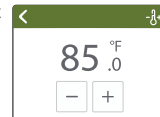

 **Humidity Setpoint Adjustment**  
Click this icon to access the setpoint change menu. Mutually exclusive with humidity and fan speed. Set by DIP switch.\*

Submenu Only

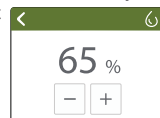

 **Fan Speed**  
Click this icon to access the fan speed menu. Mutually exclusive with humidity and fan speed. Set by DIP switch.

Submenu Only

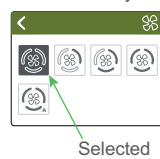

\* Does not appear on temperature-only models.

## LCD Display Operation Button Functions

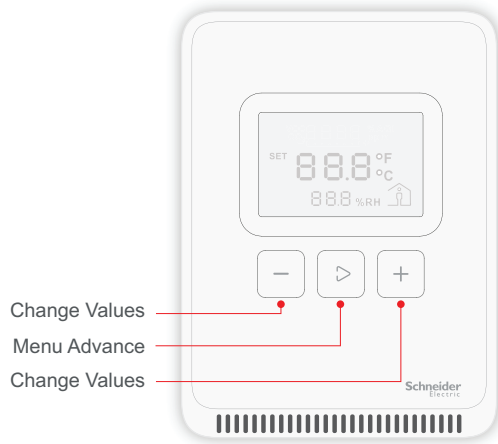

## Display Icons

The main screen displays sensor values for RH (if equipped), temperature and Celsius/Fahrenheit.

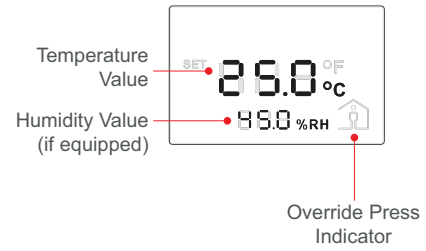

## Setpoint Function

A single 0-10V setpoint (temperature, RH (if equipped) or fan speed) can be selected via DIP switch.

### Temperature Setpoint Adjustment

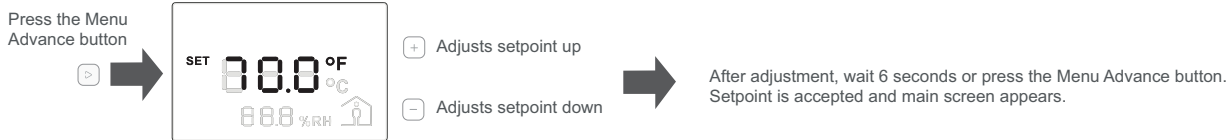

Note: Numeric information will flash while in Set mode.

### RH Setpoint Adjustment

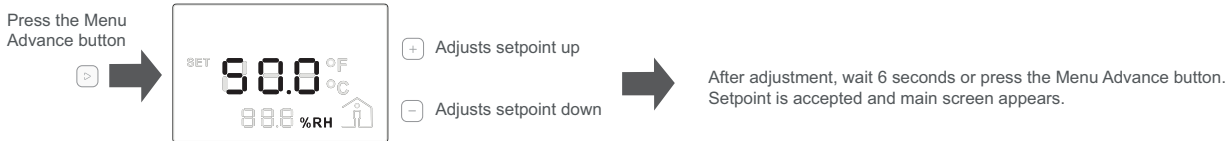

Note: Numeric information will flash while in Set mode.

### Fan Speed Setpoint Adjustment

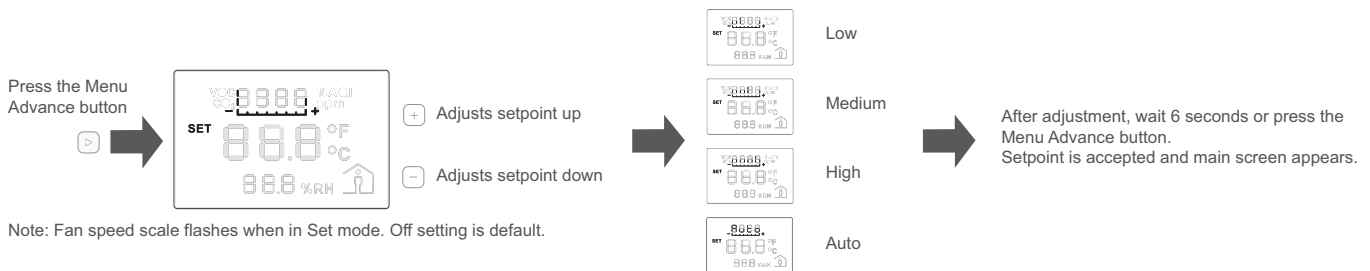

Note: Fan speed scale flashes when in Set mode. Off setting is default.

USA: +1 888-444-1311  
Europe: +46 10 478 2000  
Asia: +65 6484 7877  
www.schneider-electric.com

Life Is On

Schneider  
Electric

## Setpoint Function (cont.)

### Changing Celsius and Fahrenheit Scales

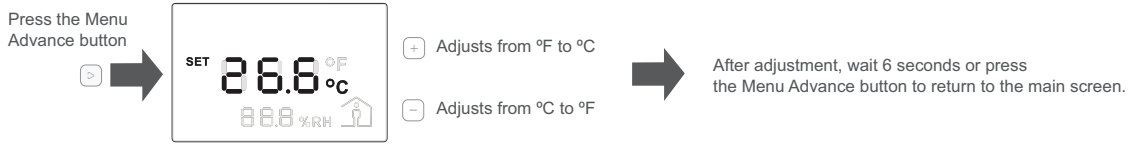

Note: °F or °C text will flash while in Set mode.

### Occupied/Override Button

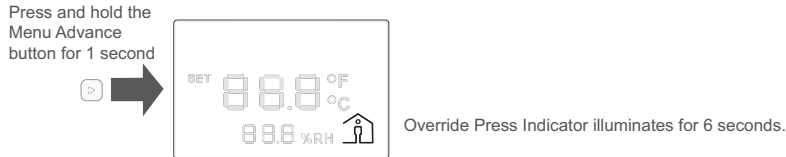

## China RoHS Compliance Information Environment-Friendly Use Period (EFUP) Table

部件名称	有害物质 - Hazardous Substances					
Part Name	铅 (Pb)	汞 (Hg)	镉 (Cd)	六价铬 (Cr (VI))	多溴联苯 (PBB)	多溴二苯醚 (PBDE)
电子件 Electronic	X	O	O	O	O	O

本表格依据SJ/T11364的规定编制。

- O: 表示该有害物质在该部件所有均质材料中的含量均在GB/T 26572规定的限量要求以下。
- X: 表示该有害物质至少在该部件的某一均质材料中的含量超出GB/T 26572规定的限量要求。  
(企业可在此处，根据实际情况对上表中打“X”的技术原因进行进一步说明。)

This table is made according to SJ/T 11364.

O: indicates that the concentration of hazardous substance in all of the homogeneous materials for this part is below the limit as stipulated in GB/T 26572.

X: indicates that concentration of hazardous substance in at least one of the homogeneous materials used for this part is above the limit as stipulated in GB/T 26572

Z000057-0B