



LMS511-20190

Bulkscan®

FLOW SENSORS

SICK
Sensor Intelligence.



Illustration may differ



Ordering information

Type	Part no.
LMS511-20190	1059529

Other models and accessories → www.sick.com/Bulkscan

Detailed technical data

Features

Light source	Infrared (905 nm)
Laser class	1, eye-safe (IEC 60825-1:2014)
Aperture angle	190°
Scanning frequency	35 Hz 50 Hz 75 Hz
Bandwidth	No limit
Heating	Yes
Working range	0.5 m ... 20 m
Amount of evaluated echoes	5

Mechanics/electronics

Electrical connection	M12 round connector
Supply voltage scanner/heater	19.2 V ... 28.8 V
Prohibited residual ripple	± 5 %
Switch-on peak current	2 A
Operating current scanner	≤ 1.3 A
Power consumption	22 W, + 55 W heating (typical)
Housing color	Gray (RAL 7032)
Enclosure rating	IP67 (according to IEC 60529)
Protection class	III
Weight	3.7 kg
Dimensions	160 mm x 155 mm x 185 mm
Distance of the sensor to the bulk solid	≥ 0.5 m
Switch-on time	≤ 60 s

Performance

Response time	13 ms, 20 ms, 28 ms
Average filter	0 s ... 3,600 s
Accuracy	± 3 %, at reference conditions
Max. conveyor speed	≤ 30 m/s

Interfaces

Auxiliary interface	✓
Protocol	USB 2.0
Data transmission rate	≤ 500 kBaud
Serial host interface	✓
Protocol	RS-232/RS-422
Data transmission rate	≤ 500 kBaud
Ethernet	✓
Protocol	TCP/IP
Data transmission rate	100 Mbit/s
Switching inputs	2 (+ Encoder)
Switching outputs	6
Analog signals	Available with separate accessory BAM100
Communication interface	Auxiliary interface, 1, USB 2.0, 500 kBaud Serial host interface, 1, RS-232/RS-422, 500 kBaud Ethernet, 1, TCP/IP, 100 Mbit/s
Optical indicators	5 LEDs (Additional 7-segment display)

Ambient data

Electromagnetic compatibility (EMC)	IEC 61000-6-2:2016-08 / IEC 61000-6-3:2006-07 / EN 61000-6-2:2005 / EN 61000-6-3 / A1 2011
Ambient operating temperature	-40 °C ... +60 °C
Storage temperature	-40 °C ... +70 °C
Ambient light immunity	70,000 lx

Classifications

ECl@ss 5.0	27200413
ECl@ss 5.1.4	27200413
ECl@ss 6.0	27200413
ECl@ss 6.2	27200413
ECl@ss 7.0	27200413
ECl@ss 8.0	27200413
ECl@ss 8.1	27200413
ECl@ss 9.0	27200413
ECl@ss 10.0	27200413
ECl@ss 11.0	27200413
ETIM 5.0	EC002580
ETIM 6.0	EC002580
ETIM 7.0	EC002580

UNSPSC 16.0901

41112501

Dimensional drawing (Dimensions in mm (inch))

Bulkscan® LMS511

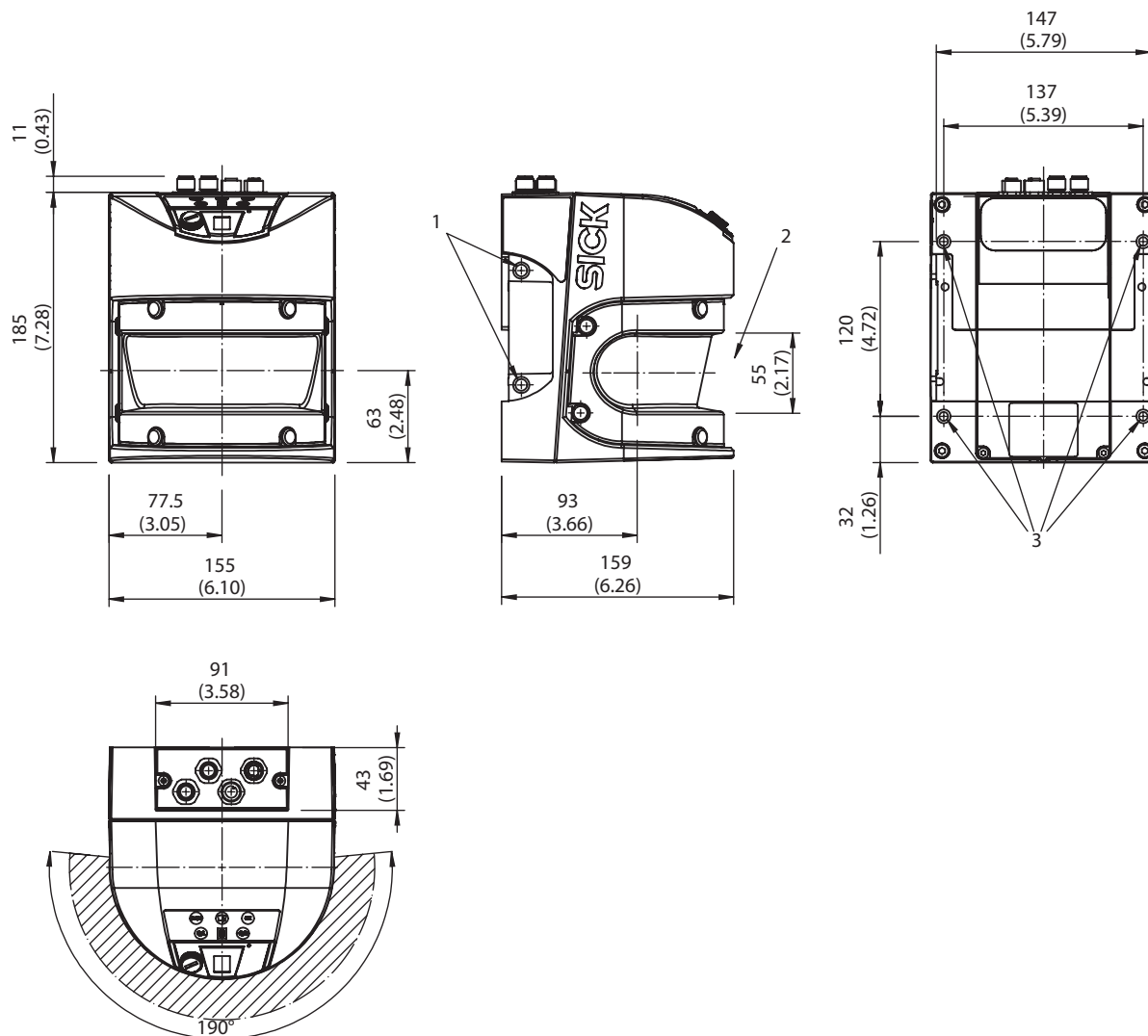

- ① 4 screw holes M8 x 9
- ② Do not block front screen
- ③ 4 screw holes M6 x 8

Application

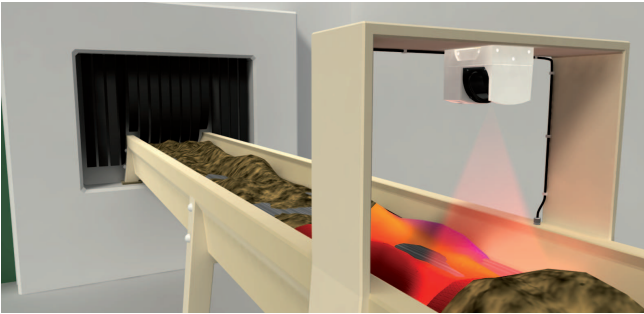

Instruction for installation

Mounting bracket

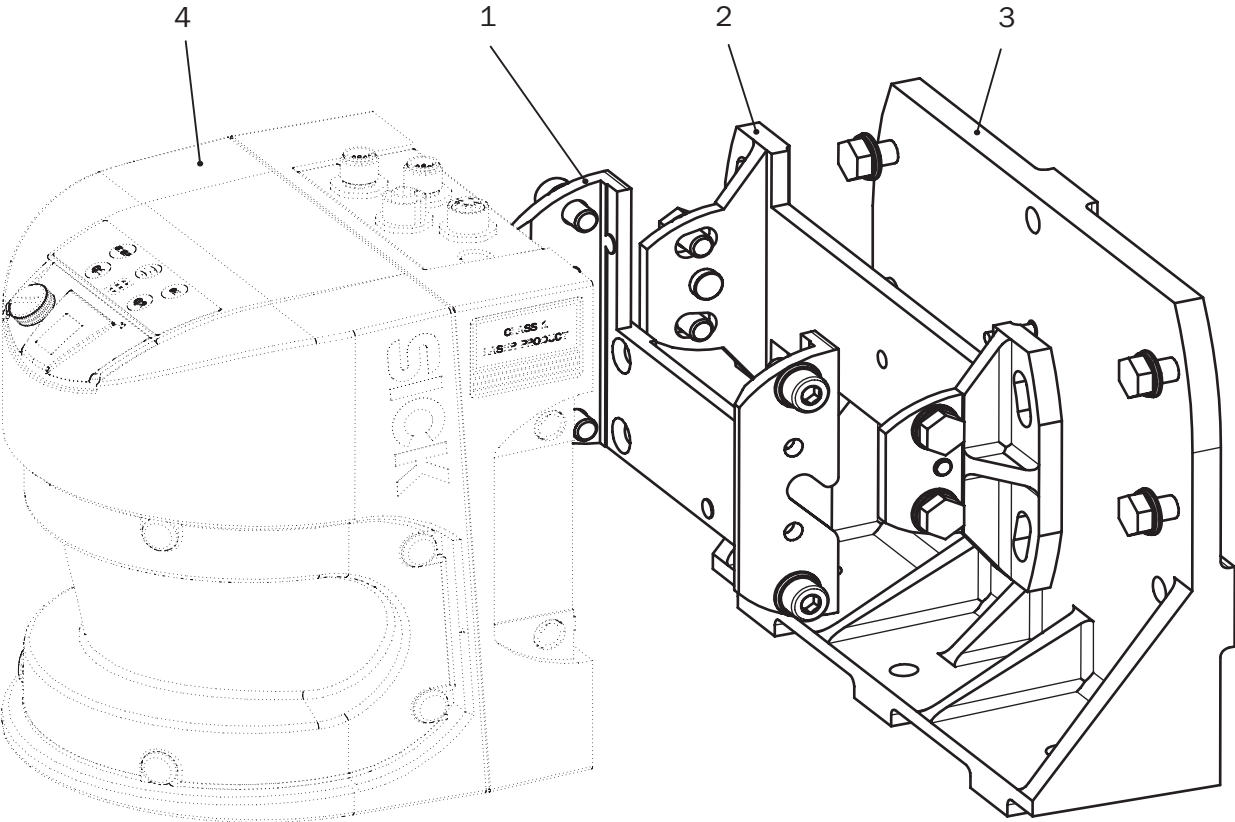

- ① Mounting kit 1
- ② Mounting kit 2
- ③ Mounting kit 3
- ④ Device

Bulkscan® LMS511 / Bulkscan® LMS111

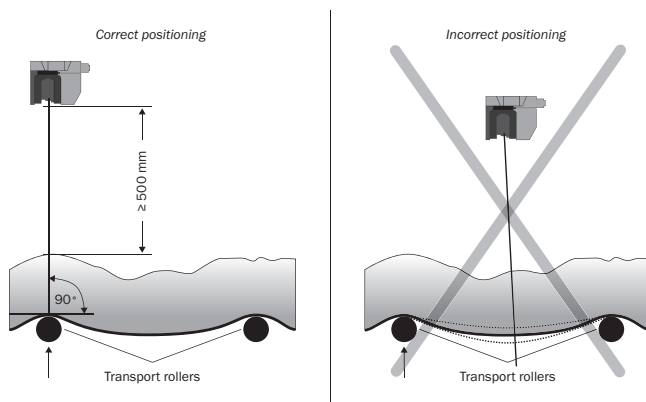

Post bracket

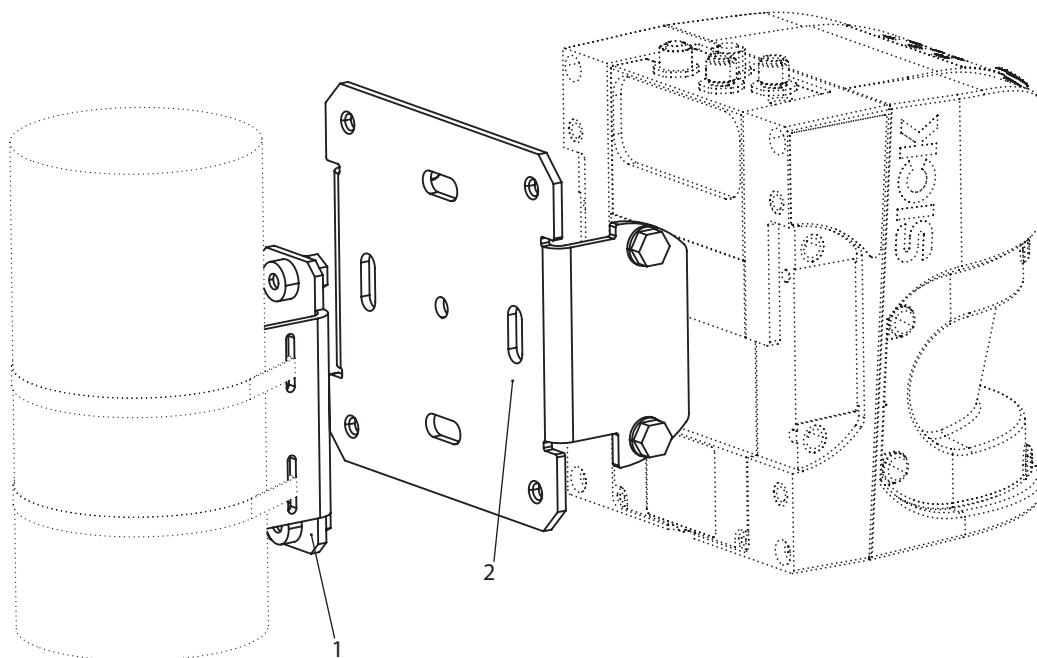

- ① Post bracket
- ② Adapter bracket



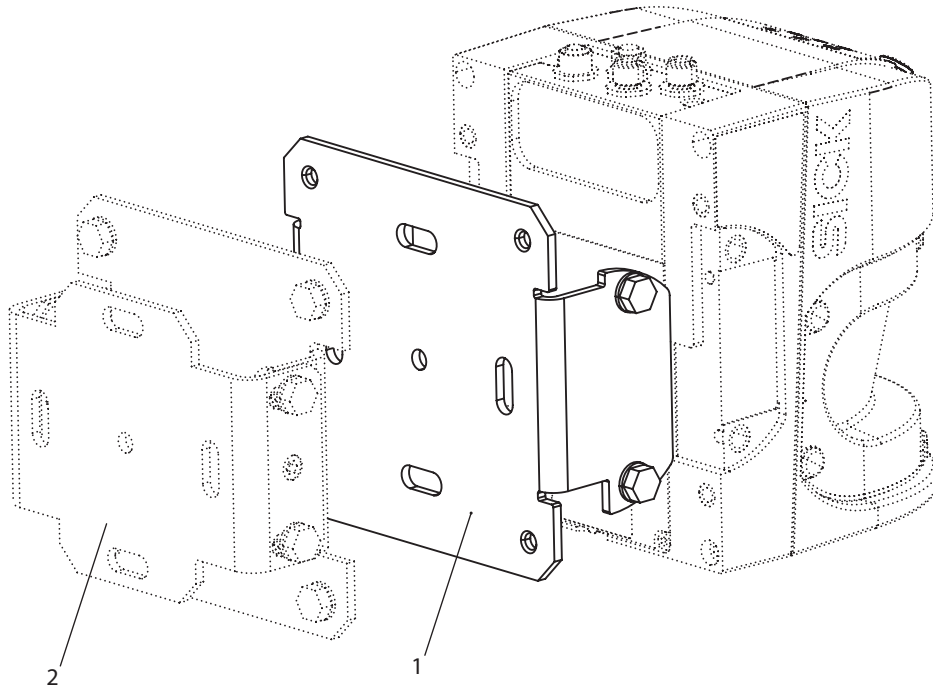



Mounting bracket

















- ① Mounting bracket
- ② Mounting set for LMS2xx Part no. 2018303

Recommended accessories

Other models and accessories → www.sick.com/Bulkscan

	Brief description	Type	Part no.
Device protection (mechanical)			
	Weather hood (180°), vertical mounting, Aluminum (powder-coating)	Weather protection hood	2063050
Mounting brackets and plates			
	Spring arm / mounting arm for DFV60	DFV60 sprung arm	2056155
	Mounting bracket for LMS5xx (for retrofitting, if 2018303 is already in use), Stainless steel V2A (1.4301)	Mounting bracket	2059271
	1 piece, mounting bracket for direct mounting, from the rear, on wall or machine, not adjustable, Aluminum	Mounting kit 1	2015623
	1 piece, mounting bracket for rear mounting on wall or machine, adjustable longitudinal and lateral axes, only in conjunction with mounting kit 1 (2015623), Aluminum	Mounting kit 2	2015624
	1 piece, mounting bracket for rear mounting on wall, floor, or machine, adjustable longitudinal and lateral axes, only in conjunction with mounting kit 1 (2015623) and 2 (2015624), Aluminum	Mounting kit 3	2015625

	Brief description	Type	Part no.
Other mounting accessories			
	Strap lock	Adjustable strap lock	5306221
	Strap for mast bracket (sold by meter)	Tension strap	5306222
Terminal and alignment brackets			
	Pole bracket requires additionally adapter bracket (2059271) or mounting set (2018303)	Mast mounting bracket	2018304
Incremental encoders			
	<ul style="list-style-type: none"> Mechanical design: Blind hollow shaft 15 mm Communication interface: 10 V ... 32 V, HTL, Push pull Connection type: Male connector, M12, 8-pin, radial Pulses per revolution: 1,024 	DFS60E-BHEC01024	1036541
	<ul style="list-style-type: none"> Mechanical design: Solid shaft face mount flange 10 mm x 19 mm Communication interface: 10 V ... 32 V, HTL, Push pull Connection type: Cable, 8-wire, universal, 1.5 m Pulses per revolution: 1,024 	DFS60E-S4EK01024	1037534
Measuring wheel encoders			
	<ul style="list-style-type: none"> Measuring wheel circumference: 300 mm Measuring wheel surface: O-ring NBR70 Communication interface: Push pull 10 V ... 32 V Supply voltage: 10 V ... 32 V Connection type: Male connector, M12, 8-pin, radial Resolution in pulses/mm: 3.41 	DFV60E-22EC01024	1060308
	<ul style="list-style-type: none"> Measuring wheel circumference: 300 mm Measuring wheel surface: O-ring NBR70 Communication interface: Push pull 10 V ... 32 V Supply voltage: 10 V ... 32 V Connection type: Cable, 8-wire, universal, 1.5 m Resolution in pulses/mm: 3.41 	DFV60E-22EK01024	1060309
Optics cloths			
	Cloth for cleaning optical surfaces	Lens cloth	4003353
Power supply units and power supply cables			
	Power supply DC 24 V / 10 A	Power supply	6020875
	BAM100 analog module for Bulkscan, by Beckhoff, 24 V DC supply voltage (-15% / + 20%), rail mounting on 35 mm C rail, according to EN 50022 with interlocking, Ethernet TCP/IP interface (RJ45), CoLa communication, 3 x IN: 4 mA ... 20 mA, 4 x OUT: 4 mA ... 20 mA	BAM100-HE44K	2073296
Cleaning agent			
	Plastic cleaner and care product, anti-static, 0.5 liter	Plastic cleaner	5600006

	Brief description	Type	Part no.
Test and monitoring tools			
	Scan finder, receiver to localize infrared scans	Scan-Finder LS-80L	6020756
Plug connectors and cables			
	Head A: female connector, M12, 12-pin, straight, A-coded Head B: Flying leads Cable: Sensor/actuator cable, I/O, twisted pair, PUR, halogen-free, shielded, 5 m	YF2A2B-050UD3XLEAX	6042735
	Head A: female connector, M12, 12-pin, straight, A-coded Head B: Flying leads Cable: Sensor/actuator cable, I/O, twisted pair, PUR, halogen-free, shielded, 10 m	YF2A2B-100UD3XLEA	6042736
	Head A: female connector, M12, 12-pin, straight, A-coded Head B: Flying leads Cable: Sensor/actuator cable, I/O, twisted pair, PUR, halogen-free, shielded, 20 m	YF2A2B-200UD3XLEAX	6042737
	Head A: female connector, M12, 5-pin, straight, A-coded Head B: Flying leads Cable: Power, shielded, 5 m	YF2A64-050XXXLEAX	6036159
	Head A: female connector, M12, 5-pin, straight, A-coded Head B: Flying leads Cable: shielded, 10 m	YF2Z15-100UE1XLEAX	6042565
	Head A: female connector, M12, 5-pin, straight, A-coded Head B: Flying leads Cable: shielded, 20 m	YF2Z15-200UE1XLEAX	6042564
	Head A: male connector, M12, 12-pin, straight, A-coded Head B: Flying leads Cable: Sensor/actuator cable, I/O, twisted pair, PUR, halogen-free, shielded, 5 m	YM2A2B-050UD3XLEAX	6042732
	Head A: male connector, M12, 12-pin, straight, A-coded Head B: Flying leads Cable: Sensor/actuator cable, I/O, twisted pair, PUR, halogen-free, shielded, 10 m	YM2A2B-100UD3XLEAX	6042733
	Head A: male connector, M12, 12-pin, straight, A-coded Head B: Flying leads Cable: Sensor/actuator cable, I/O, twisted pair, PUR, halogen-free, shielded, 20 m	YM2A2B-200UD3XLEAX	6042734
	Head A: male connector, M12, 4-pin, straight, D-coded Head B: male connector, RJ45, 8-pin, straight Cable: Ethernet, twisted pair, PUR, halogen-free, shielded, 5 m	YM2D24-050EA1MRJA4	6034415
	Head A: male connector, M12, 4-pin, straight, D-coded Head B: male connector, RJ45, 8-pin, straight Cable: Ethernet, twisted pair, PUR, halogen-free, shielded, 10 m	YM2D24-100EA1MRJA4	6030928
	Head A: male connector, M12, 4-pin, straight, D-coded Head B: male connector, RJ45, 8-pin, straight Cable: Ethernet, twisted pair, PUR, halogen-free, shielded, 20 m	YM2D24-200EA1MRJA4	6036158

SICK AT A GLANCE

SICK is one of the leading manufacturers of intelligent sensors and sensor solutions for industrial applications. A unique range of products and services creates the perfect basis for controlling processes securely and efficiently, protecting individuals from accidents and preventing damage to the environment.

We have extensive experience in a wide range of industries and understand their processes and requirements. With intelligent sensors, we can deliver exactly what our customers need. In application centers in Europe, Asia and North America, system solutions are tested and optimized in accordance with customer specifications. All this makes us a reliable supplier and development partner.

Comprehensive services complete our offering: SICK LifeTime Services provide support throughout the machine life cycle and ensure safety and productivity.

For us, that is “Sensor Intelligence.”

WORLDWIDE PRESENCE:

Contacts and other locations –www.sick.com