

Desigo™ Control Point

## BACnet/IP Touch panels 7.0", 10.1" and 15.6"

PXM30.E, PXM40.E, PXM50.E and wall-mount frames PXA.V40, PXA.V50



**High-quality touch panels for technical on-site operation of plants as well as room operation.**

- Optimized for local on-site operation of the Desigo building automation and control system
- Integrated web server with HTML5.0 interface
- Generic operation and monitoring of plant functions (alarms, schedulers, calendars, setpoint changes, display of actual values, etc.)
- Offline engineering of customized graphics with ABT site
- Compact design featuring a low installation depth for mounting in panel doors
- Wall mounting with installation frames for PXM40.E, PXM50.E (ordered separately)
- High-resolution, capacitive touch displays (landscape)
- LED to display alarms on an inactive screen
- Operating voltage AC 24 V, DC 24 V, or Power over Ethernet (PoE) (PXM40.E and PXM50.E)

## Use

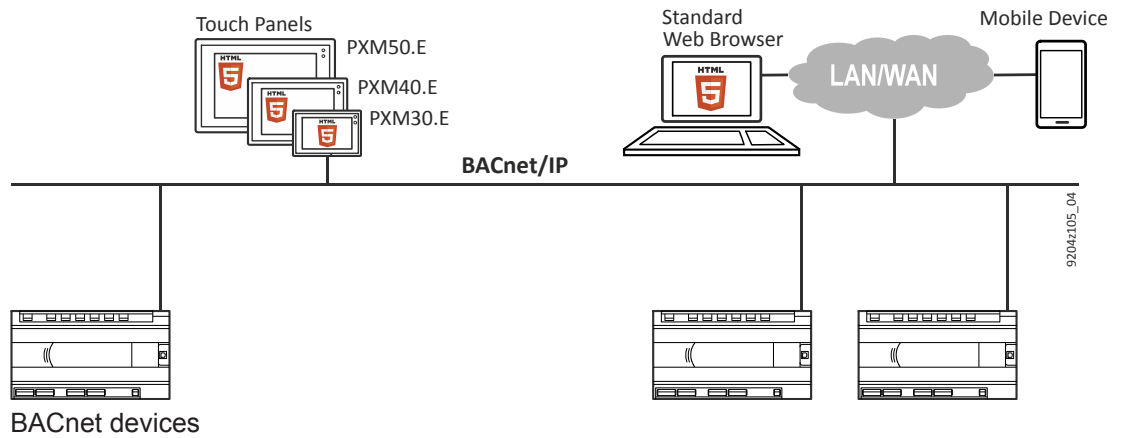

Touch panels are highly flexible and scalable:

- Plant operation by technicians
- Operation of various room environments by the end user
- Examples: Offices, conference rooms, or even entire floors

## Functions

Example for a plant graphic

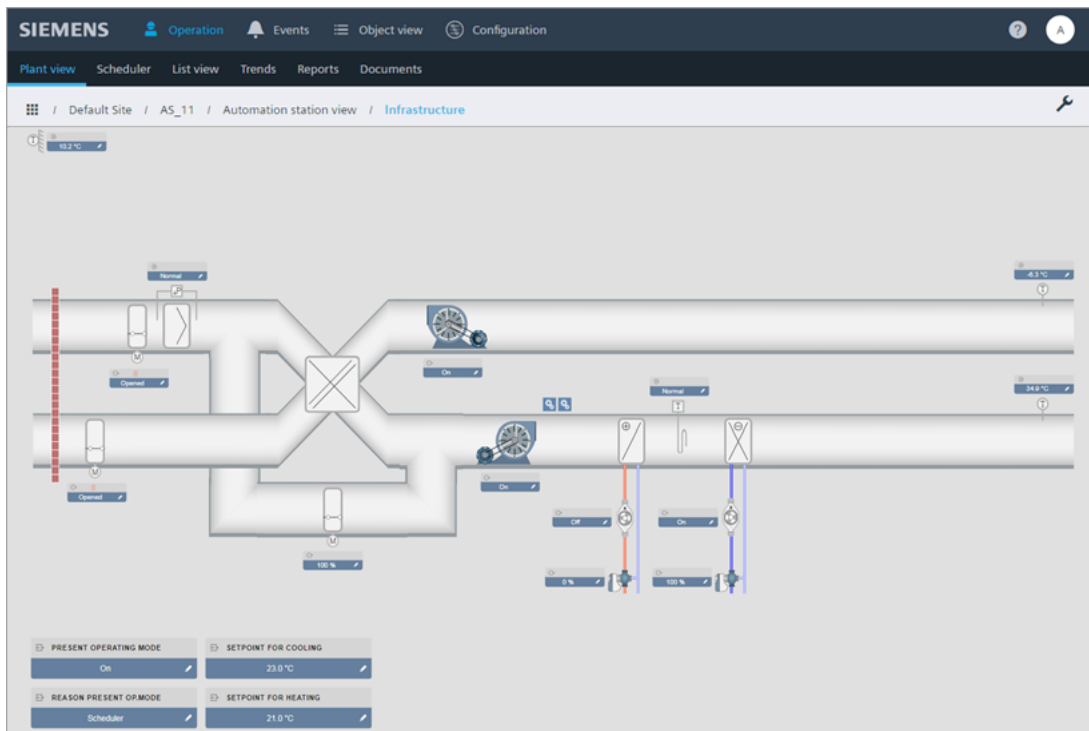

## Settings

Different settings are available, however, for user-friendly operation of the touch panel. They can be edited after login.

For details, see "Desigo Touch Panel client commissioning", A6V11604303.

Function	Description																					
Brightness	Sets the screen's brightness.																					
Time format	24 hours or 12 hours (am/pm).																					
Date format	8 variants are available.																					
Language	Touch panel operating language: Supports 21 languages; the factory setting for the user interface is English.																					
	<table border="0"> <tr> <td>Czech</td> <td>Hungarian</td> <td>Russian</td> </tr> <tr> <td>Danish</td> <td>Italian</td> <td>Simplified Chinese</td> </tr> <tr> <td>Dutch</td> <td>Korean</td> <td>Traditional Chinese</td> </tr> <tr> <td>English</td> <td>Norwegian</td> <td>Slovak</td> </tr> <tr> <td>Finnish</td> <td>Polish</td> <td>Spanish</td> </tr> <tr> <td>French</td> <td>Portuguese</td> <td>Swedish</td> </tr> <tr> <td>German</td> <td>Romanian</td> <td>Turkish</td> </tr> </table>	Czech	Hungarian	Russian	Danish	Italian	Simplified Chinese	Dutch	Korean	Traditional Chinese	English	Norwegian	Slovak	Finnish	Polish	Spanish	French	Portuguese	Swedish	German	Romanian	Turkish
Czech	Hungarian	Russian																				
Danish	Italian	Simplified Chinese																				
Dutch	Korean	Traditional Chinese																				
English	Norwegian	Slovak																				
Finnish	Polish	Spanish																				
French	Portuguese	Swedish																				
German	Romanian	Turkish																				
Keyboard	The interaction with the keyboard is roughly the same as commercially available products such as smart phones, tablets, etc.																					
Auto logout	Time to logout: 5, 10, 15, 30, 45, 60 minutes The automatic logout can be set at intervals of 5 to 60 minutes, including the ability to suppress automatic logout for certain technical reasons.																					
Screensaver	Screensaver time: 5, 10, 15, 30, 45, 60 minutes and 10 hours Default time: 15 min.																					
Warning: Changing the screen saver time from the default setting to 10 h can reduce the device life time. The impact on the device life time must be calculated depending on the individual use case and the specified display life time (technical data p. 6).																						

## Function overview

For functions and system limits, see:

BACnet systems

- Desigo Control Point Engineering manual, A6V11604297
- Desigo Control Point Basic documentation, A6V11666339

Desigo system

- Desigo Control Point Engineering manual, A6V11211560
- Desigo Control Point Basic documentation, A6V11170804

## Type summary

Type	Stock number	Description
PXM30.E	S55623-H128	BACnet/IP Touch Panel 7" with integrated web server
PXM40.E	S55623-H129	BACnet/IP Touch Panel 10" with integrated web server
PXM50.E	S55623-H130	BACnet/IP Touch Panel 15" with integrated web server

## Accessories

Type	Stock number	Description	Document no.
PXA.V40	S55842-Z119	Wall-mount frame for flush mounting of PXM40.E	
PXA.V50	S55842-Z120	Wall-mount frame for flush mounting of PXM50.E	
PXA.S30	S55842-Z123	Mounting set for surface mounting of PXM30.E	A6V11646070

The accessories must be ordered separately.

Document	BACnet systems	Desigo system
Desigo Control Point Basic documentation	A6V11666339	A6V11170804
Desigo Control Point Engineering manual	A6V11604297	A6V11211560
Desigo Control Point User's Guide	A6V11211557	
Desigo Touch Panel client commissioning	A6V11604303	
ABT Site Online help	--	

Related documents such as the environmental declarations, CE declarations, etc., can be downloaded from the following Internet address:

<https://siemens.com/bt/download>

## Notes

### Safety

 <b>CAUTION</b>	
	<p><b>National safety regulations</b></p> <p>Failure to comply with national safety regulations may result in personal injury and property damage.</p> <ul style="list-style-type: none"> <li>Observe national provisions and comply with the appropriate safety regulations.</li> </ul>

### Engineering

For additional information on cable lengths, topology, etc.:  
See Desigo Control Point Basic documentation, A6V11170804

### Mounting

The devices are suitable for installation in panel doors  
Mounting frames are available for wall mounting (ordered separately, see accessories):

- PXM40.E and PXM50.E (flush mounting e.g. cavity walls)
- PXM30.E (surface mounting, e.g. panels doors or walls)

#### Mounting instructions

Mounting installations are printed on the unit's packaging material.

#### Cut outs for panel installation and wall mounting

See "Dimensions".

### Installation

Power is connected to a plug-in screw terminal block.  
This connection is not required for Power over Ethernet (PoE).

### Commissioning

Touch panels can be commissioned without tools.  
All necessary network parameters can be entered directly on the unit.  
No additional engineering required for operation using default views.  
Each device has a unique identification number to ensure efficient commissioning.  
It is also printed on the removable barcode label.

## LED display (front side)

Color	Activity	Function
Green	Off	Device is not powered
	Flashing	Start-up or the program is stopped
	On	Device is operational and no pending events <sup>1)</sup>
Red	Off	OK
	On	Program error Hardware fault Pending events <sup>1)</sup>
	Flashing 1 Hz	Wrong or corrupt software No application loaded Faulty server-link configuration <sup>2)</sup>
	Flashes in wink command rhythm	Physical device identification

<sup>1)</sup> event status is only shown for integrated data points

<sup>2)</sup> for example when using a different web server than Desigo Control Point

## Service button (rear side) (Only for devices with series B and higher, see printing on the device)

	Press	Description
	Short	Physical identification on the network (Ethernet)
	As per description	<p>Do the following to reset the device to factory state:</p> <ol style="list-style-type: none"> <li>1. Power off the device.</li> <li>2. Power on the device.</li> <li>3. Wait until the LED lights up and turns off again, then press the Service button.</li> <li>4. Keep the Service button pressed until the LED lights up again, then release the button.</li> <li>5. Wait until the device has fully started – unconfigured (LED flashes red/green)</li> </ol> <p>Pre-loaded apps are still available. The FW remains unchanged</p>

## Maintenance

### Cleaning

Touch panels are maintenance free.

Dirt on the display can be cleaned using off-the-shelf display cleaners for smart phones, a moist rag, and/or off-the-shelf microfiber cloth for monitors or glasses.

Recommended products:

- Lysol towel
- Clorex towel
- Water with 2% alcohol
- Damp microfiber cloth
- H<sub>2</sub>O<sub>2</sub> hydrogen peroxide
- Sterillium® Classic Pure

### Firmware upgrade

You can update the firmware with ABT Site tool. We support firmware updates throughout the product life cycle. If necessary, please inform you via the Siemens Industry Online Support (SIOS) portal page.

### Repair

For possible repairs or spare parts, please contact your Siemens customer service or inform yourself via the Siemens Industry Online Support (SIOS) portal page. Repairs may only be carried out by approved repair companies.

### Product support

Product support for the devices is offered throughout the product life cycle.

## Disposal

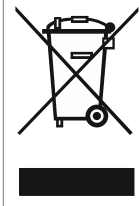

The device is considered an electronic device for disposal in accordance with the European Guidelines and may not be disposed of as domestic garbage.

- Dispose of the device through channels provided for this purpose.
- Comply with all local and currently applicable laws and regulations.

## Technical data

### Power supply and HW information

Power supply type	Internal		
Operating voltage Safety Extra-Low Voltage SELV or Protection by Extra Low Voltage per HD384	AC 24 V $\pm 20\%$ (SELV / PELV) AC 24 V class 2 (US) DC 24 V $\pm 15\%$ (SELV / PELV) DC 24 V class 2 (US)		
PoE: PoE switches and injectors must comply with IEEE 802.3at	DC 48 V (PoE Class 4, alternative A) (PXM40.E, PXM50.E only)		
Frequency	50/60 Hz		
Maximum power consumption At AC 24 V At DC 24 V PoE *)	<b>PXM30.E</b> Max. 29 VA Max. 17 W --	<b>PXM40.E</b> Max. 32 VA Max. 21 W Max. 22 W *)	<b>PXM50.E</b> Max. 42 VA Max. 26 W Max. 25 W *)
*) Applies to normal operation. Can be higher at start-up (IEEE 802.3at Class 4)			
Processor	Texas Instruments AM5727, 1.5 GHz, Dual Core		
Memory	8 GB eMMC, 2 GB SDRAM (DDR3L)		
Operating system	Linux		
Screw terminals for wire cross sections up to	2.5 mm <sup>2</sup>		
External supply line fusing (EU) At AC / DC 24 V power	Non-renewable fuse max. 10 A slow ... or circuit breaker max. 13 A Tripping characteristic B, C, D per EN 60898 ... or Power supply with current limitation of max. 10 A		

### Display

	PXM30.E	PXM40.E	PXM50.E
Size			
Diagonal	7.0"	10.1"	15.6"
W x H	15.4 x 8.7 cm	21.7 x 13.6 cm	34.4 x 19.4 cm
Visible screen area	134 cm <sup>2</sup>	295 cm <sup>2</sup>	667 cm <sup>2</sup>
Resolution	1024 x 600	1280 x 800	1366 x 768
Type	TFT-LCD		
Display category	Status display or control panel		
Number of colors	16.2 mn		
Viewing angle H/V typical	120 / 110°	150 / 145°	
Backlit display	LED, dimmable		
Touch pad	Projective capacitive		
Life time at ambient temperature 20 °C (68 °F)	30,000 hours	50,000 hours	50,000 hours

## Connections

Screw terminals, plug-in	
Cu-wire or Cu-strand with wire end sleeve	1 x 0.6 mm $\emptyset$ to 2.5mm <sup>2</sup> (22 to 14 AWG) or 2 x 0.6 mm $\emptyset$ to 1.0 mm <sup>2</sup> (22 to 18 AWG)
Cu-strand without wire end sleeve	1 x 0.6 mm $\emptyset$ to 2.5 mm <sup>2</sup> (22 to 14 AWG) or 2 x 0.6 mm $\emptyset$ to 1.5 mm <sup>2</sup> (22 to 16 AWG)
Stripping length	6...7.5 mm (0.24...0.29 in)
Slotted screws	Screwdriver, size 1 with shaft $\emptyset \leq 4.5$ mm
Max. tightening torque	0.6 Nm (0.44 lb ft)

Ethernet interface	
Plug	RJ45, screened
Interface type	100BASE-TX, IEEE 802.3 compatible
Bit rate	10/100 Mbps, autosensing
Protocol	BACnet over UDP/IP
Galvanic isolation of system neutral	Yes

Interface USB 2.0	
Plug	Type B (device)
Data rate (USB 2.0 full speed)	12 Mbps
Protective switch against surges and over current	Yes
Galvanic isolation of system neutral	No

## Conformity

Ambient conditions and protection classification	
Assigned per EN 62368-1 <ul style="list-style-type: none"> <li>Degree of pollution</li> <li>Overvoltage category</li> </ul>	<ul style="list-style-type: none"> <li>2</li> <li>III</li> </ul>
Design	Device suited for use with equipment of safety classes I and II
Degree of protection of housing to EN 60529 <ul style="list-style-type: none"> <li>From the front</li> <li>From the back (panel mounted)</li> </ul>	<ul style="list-style-type: none"> <li>IP54</li> <li>IP20</li> </ul>
Climatic ambient conditions <ul style="list-style-type: none"> <li>Transport and storage (packaged for transport) as per IEC/EN 60721-3-2 / -3-1</li> <li>Operation per IEC/EN 60721-3-3 (wall mounted)</li> <li>Operation per IEC/EN 60721-3-3 (panel mounted)</li> </ul>	<ul style="list-style-type: none"> <li>Class 1K22 / 2K12 Temperature -40...+70 °C (-40... +158 °F) Air humidity 5...95%</li> <li>Class 3K23 Operation in dry locations having no temperature or humidity control Temperature 0...40 °C (32... 104 °F) Air humidity 5...95 % (non-condensing)</li> <li>Class 3K23 Operation in dry locations having no temperature or humidity control Temperature 0...50 °C (32... 122 °F) Air humidity 5...95 % (non-condensing)</li> </ul>
Mechanical ambient conditions <ul style="list-style-type: none"> <li>Transport (in transport packaging) per IEC/EN 60721-3-2</li> <li>Operation per IEC/EN 60721-3-3</li> </ul>	<ul style="list-style-type: none"> <li>Class 2M4</li> <li>Class 3M11</li> </ul>
Elevation above sea level	Max. 3,000 m above sea level

Standards, directives and approvals	
Product standard EN 62368-1	Information Technology Equipment - Safety - Part 1
Electromagnetic compatibility	For residential, commercial, and industrial environments
EU conformity (CE)	See CE declaration <sup>1)</sup>
UK conformity (UKCA)	See UK declaration <sup>1)</sup>
EAC compliance	Eurasian compliance
RCM conformity	See RCM declaration <sup>1)</sup>
UL approbation (US)	UL 916, <a href="http://ul.com/database">http://ul.com/database</a>
cUL-Approbation (Canada)	cUL 916, <a href="http://ul.com/database">http://ul.com/database</a>
FCC	CFR 47 Part 15 Class B
CSA certification	C22.2, <a href="http://www.csagroup.org/services-industries/product-listing/">www.csagroup.org/services-industries/product-listing/</a>
BTL certified	B-OD
Environmental compatibility <sup>1)</sup>	The product environmental declaration contains data on environmentally compatible product design and assessments (RoHS compliance, materials composition, packaging, environmental benefit, disposal).

<sup>1)</sup> Documents can be downloaded at <http://siemens.com/bt/download>.

## Housing

Touch panels	PXM30.E	PXM40.E	PXM50.E
Dimensions	See "Dimensions"		
Color	Matt aluminum frame; Glass, reflecting	Matt aluminum frames; Glass, reflecting	
Weight without/with packaging	1117 / 1745	1810 / 2264 g	3788 / 4662 g

Wall mount frames	PXA.V40	PXA.V50
Dimensions	See "Dimensions"	
Color	Steel, zinc-plated	
Weight without/with packaging	1206 / 1640 g	2104 / 2917 g

## Connection terminals, service button

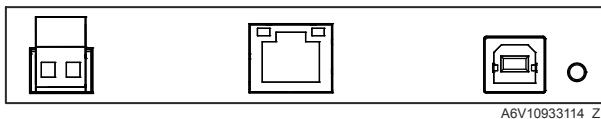

AC / DC 24 V

LAN RJ45

USB

Reset / series B and higher: Service button



## Dimensions

All dimensions provided in mm and inches.

### PXM30.E

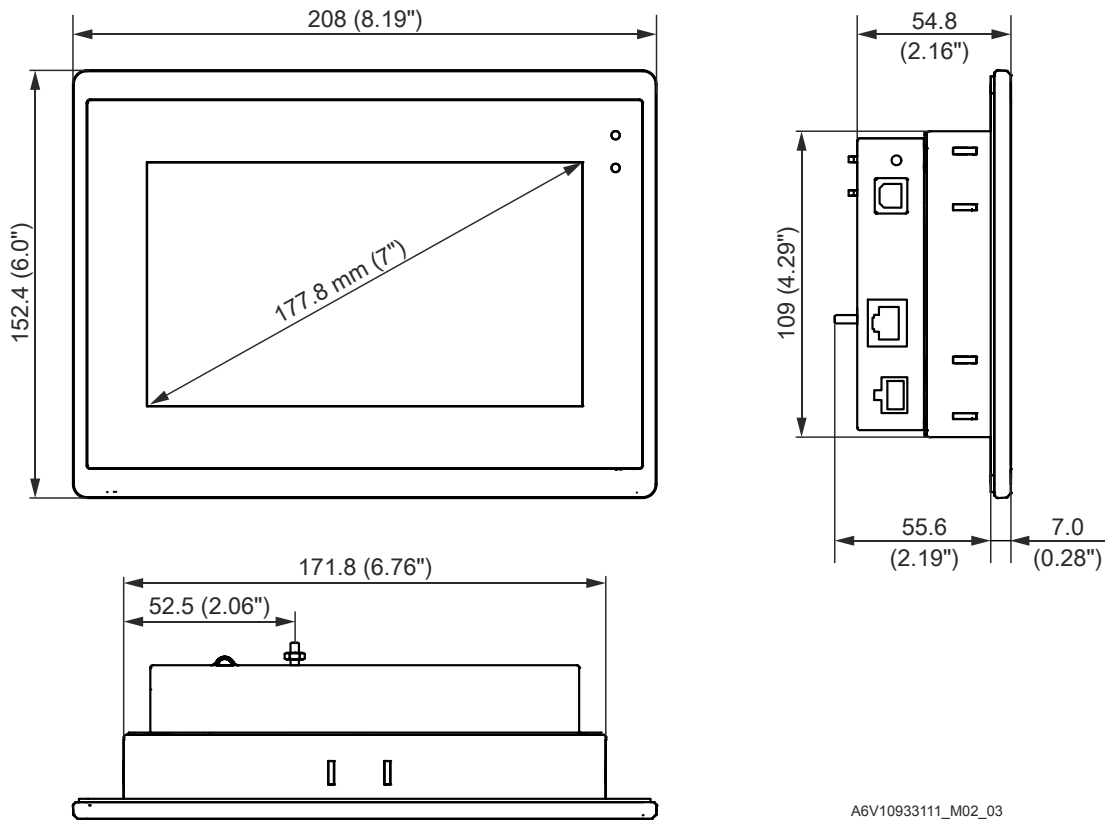

### Panel cut out

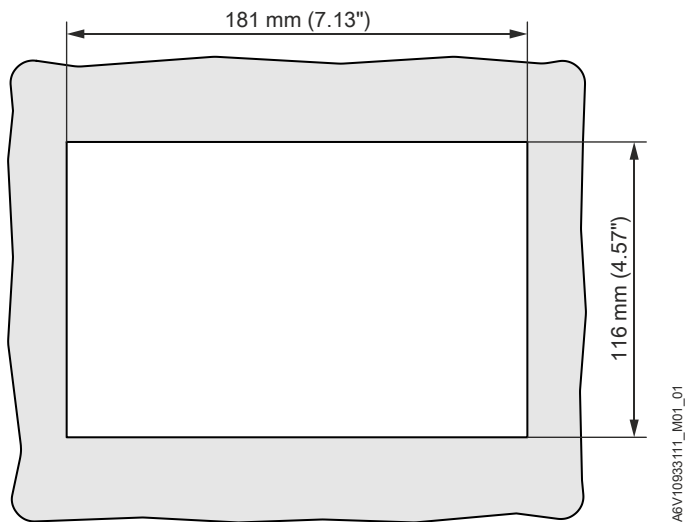

**Mounting kit PXA.S30:** see data sheet A6V11646070

**PXM40.E**

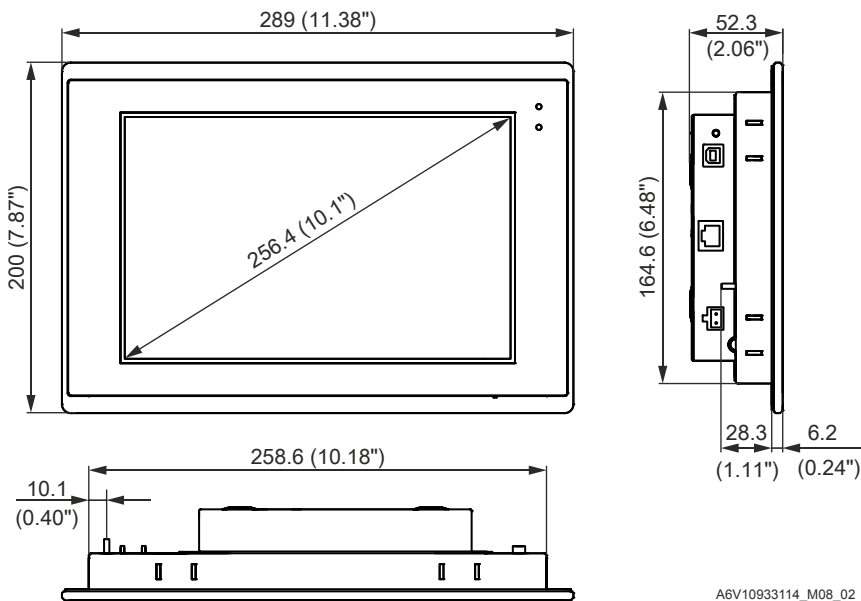

A6V10933114\_M08\_02

**PXA.V40**

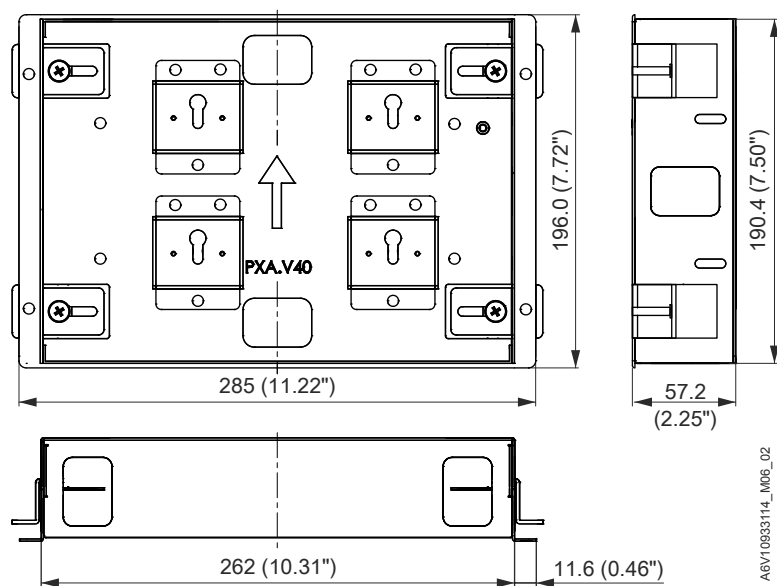

A6V10933114\_M06\_02

**Panel cut out**

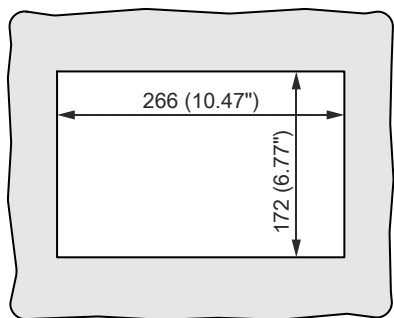

A6V10933114\_M02\_01

**Wall cut out**

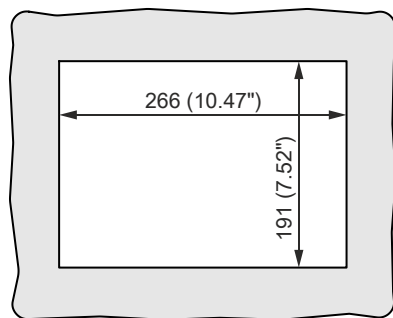

A6V10933114\_M01\_01

**PXM50.E**

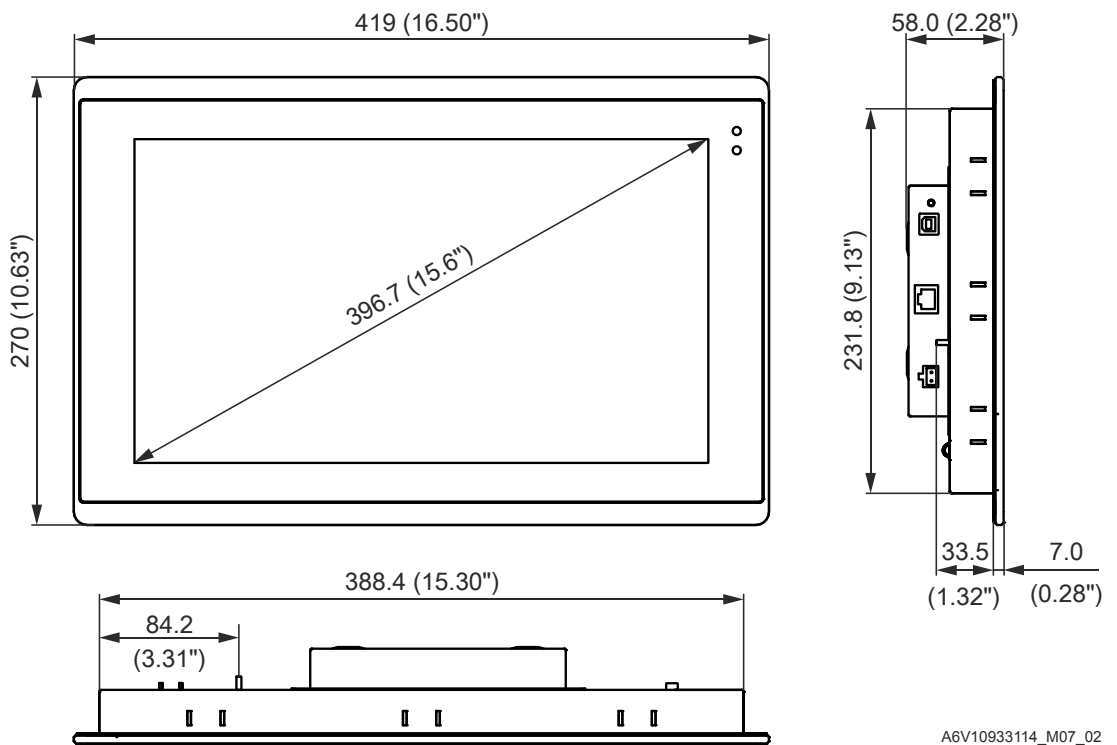

A6V10933114\_M07\_02

**PXA.V50**

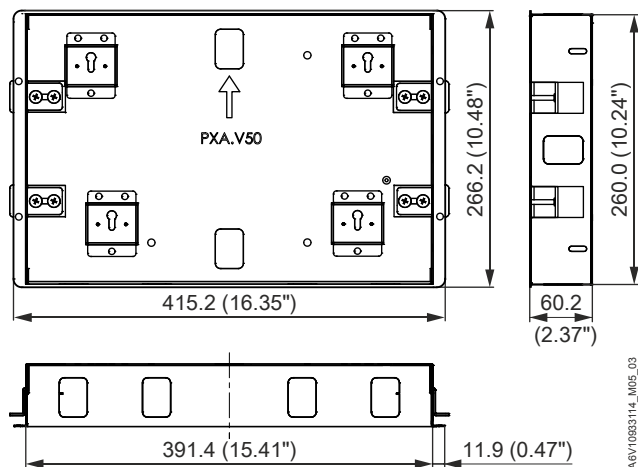

A6V10933114\_M05\_03

**Panel cut out**

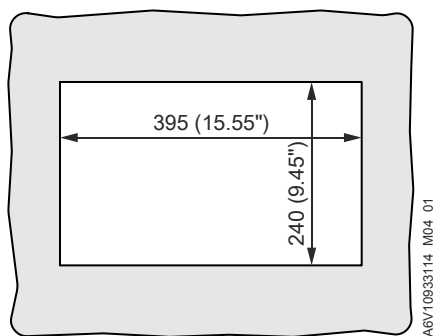

A6V10933114\_M04\_01

**Wall cut out**

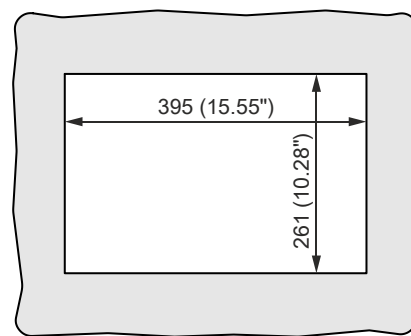

A6V10933114\_M03\_01

Issued by  
Siemens Switzerland Ltd  
Smart Infrastructure  
Global Headquarters  
Theilerstrasse 1a  
CH-6300 Zug  
+41 58 724 2424  
[www.siemens.com/buildingtechnologies](http://www.siemens.com/buildingtechnologies)

© Siemens Switzerland Ltd, 2019  
Technical specifications and availability subject to change without notice.

---

Document ID    A6V11664137\_en--\_I  
Edition        2023-03-29