

TX-I/O™

Super universal modules TXM1.8X TXM1.8X-ML

- Two fully compatible versions:
 - TXM1.8X: 8 inputs/outputs with LED signal / fault indication
 - TXM1.8X-ML: As TXM1.8X, but with additional local override facility with LCD display (LO/ID to ISO 16 484-2)
- 8 universal I/O points, individually configurable as
 - Digital input: maintained contact, pulse or counter
 - Analog input: sensor, 0..10V, 4..20mA
 - Analog output: 0..10V, 4..20mA (I/O points 5 ... 8)
- Compact DIN format, small footprint
- Separate terminal base and plug-in I/O module for convenient handling
 - Self-establishing bus connection for maximum ease of installation
 - Terminal isolation function for fast commissioning
 - I/O module replaceable in seconds, without rewiring and without affecting the full functioning of the remaining I/O modules
- All terminals are directly on the I/O modules, allowing direct connection of field devices without additional terminal strips.
- Simple strategy for operation and display
 - I/O status LED for each I/O point; mode of operation (N/C or N/O) and brightness depend on I/O function
 - LEDs and LCD for fast diagnostics
- Double-sided labels for identification of all I/O points

Functions

The modules support the following I/O functions:

Function	Signal type (TRA)	Signal type	Description
Status signal	BI NO	D20	Volt-free, interrogation (maintained contact), N/O contact
	BI NC	D20R	Volt-free, interrogation (maintained contact), N/C contact
Status pulses	BI Pulse NO BI Pulse NC	D20S	Volt-free, interrogation (pulse), N/O, N/C contact
Counter pulses	CI EI (100Hz) CI Mech (10/25Hz)	C	Volt-free, N/O contact, interrogation (pulse) Counting frequency max. 100 Hz (electronic counter) max. 25 Hz (mech. counter)
Voltage, current, resistance and temperature	AI 0-10V	U10	DC voltage 0 ... 10 V
	AI 4-20mA	I420	DC current 4 ... 20 mA
	AI 0-20mA	I25	DC current 0 ... 20 mA <i>Please note that the max. current is 20 mA!</i>
	AI 2500 Ohm	R2K5	Resistance 2500 Ω
	AI Ni1000 extended	Ni1K	Temperature sensor LG-Ni 1000 ohms, up to 180 °C
	AI Ni1000	R1K	Temperature sensor LG-Ni 1000 ohms
	AI PT1K375	Pt1K 375	Temperature sensor Pt 1000 (USA)
	AI PT1K385	Pt1K 385	Temperature sensor Pt 1000 (Europe)
	AI Pt1000	P1K	Resistance Pt 1000 ohms and resistance transmitter
	AI T1 (PTC)	T1	Temperature sensor PTC
	AI NTC10K	NTC10 K	Temperature sensor NTC 10 K
AI NTC100K	NTC100 K	Temperature sensor NTC 100 K	
Proportional output signals	AO 0-10V	Y10S	Proportional control output, DC 0 ... 10 V, with storage of control value
	AO 4-20mA	Y420	Proportional control output, current DC 4 ... 20 mA (I/O points 5 ... 8 only)

For a detailed description of these functions, please refer to document CA110561, "TX-I/O™ functions and operation".

Compatibility

Support of signal types and functions in different building automation and control systems: see TX-I/O Engineering and installation manual, CM110562

Type summary

ASN

Super universal module **TXM1.8X**
Super universal module **TXM1.8X-ML** with LCD display and local override

Delivery

The terminal base and the electronic plug-in unit are interconnected and delivered in the same box.

Accessories

The available accessories include address keys, label sheets, and spare transparent label holders. Refer to data sheet CM2N8170.

Technical and mechanical design

For a description of the features common to all TX-I/O™ modules, please refer to the TX-I/O™ Engineering and installation manual, document CM110562.

Indicators and operator controls

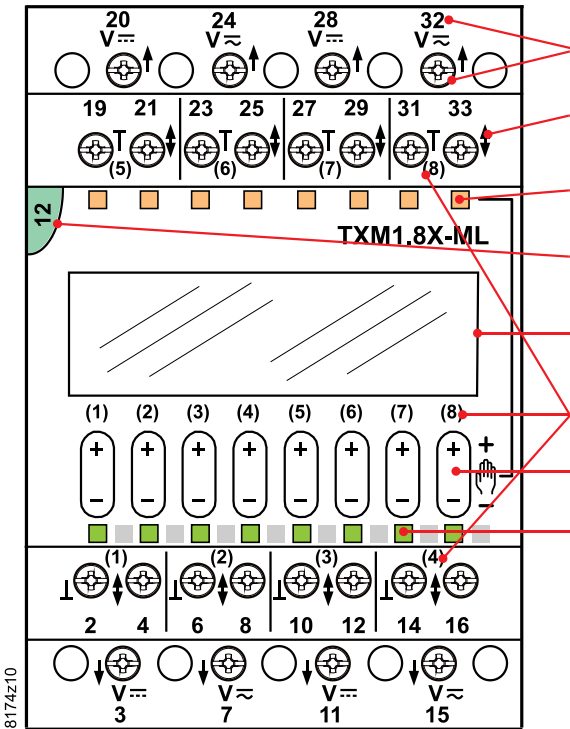

Connection terminals (No. 1 screwdriver for slotted or recessed-head * screws) with test pickup (for 1.8...2 mm pins) and terminal number

Signal designation

Override status LEDs (yellow)

Address key and module status LED

LCD panel (TXM1.8X-ML only)

I/O point numbers

Override button (TXM18X-ML only)

I/O status LEDs (green)

* Combined slotted / recessed-head screws from mid-2012

I/O status LEDs

- The I/O status LEDs (green) indicate the status of the inputs and outputs (peripheral devices)
- They are also used for diagnostics

Module status LED

- The module status LED illuminates the transparent address key
- The LED (green) shows the module status as a whole (as opposed to the status of the I/O points)
- It is also used for diagnostics

Address key

- The module operates only with the address key inserted
- The module address is mechanically encoded in the address key
- When replacing the I/O module, the address key must be swiveled outward. It remains plugged into in the terminal base.

Local override and LCD display (TXM1.8X-ML only)

For a detailed description, please refer to document CM110561, "TX-I/O™ Functions and operation".

Override button

- Pressing an button in the middle enables or disables the local override
- Pressing "+" or "-" respectively increases or reduces the output value.
- Only outputs can be overwritten. Any attempt to overwrite an input results in an error indication.

Override status LED

- The yellow "Override" LED indicates that local override is active

LCD display

- The following information is displayed for each I/O point:
 - Configured signal type
 - Symbolic display of process value
 - Information for diagnostics.
- **All safety-relevant functions must be implemented with external solutions**
- **The local override must not be used for safety shutdown operations**
- **In compliance with the standard (ISO 16 484-2, Section 3.110), the module executes all local overrides directly, without safety precautions or interlocks.**
→ **Full responsibility lies with the operator.** ←



Warning

Module labeling

The plug-in I/O module has a removable transparent cover (the label holder) for insertion of a label.

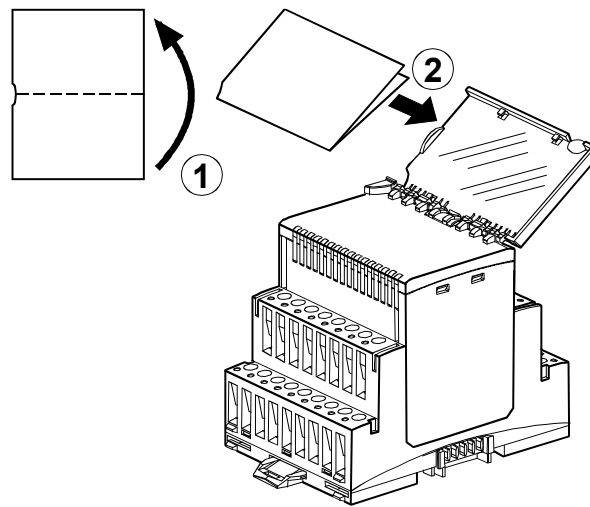

Disposal



The devices are considered electronics devices for disposal in terms of European Directive and may not be disposed of as domestic garbage.

- Dispose of the devices through channels provided for this purpose.
- Comply with all local and currently applicable laws and regulations.

Engineering, mounting, installation

Please refer to the following documents

Document	Number
TX-I/O™ functions and operation	CM110561
TX-I/O™ Engineering and installation manual	CM110562
Replacement of legacy modules	CM110563



Mounting

Permitted orientation

The TX-I/O™ devices can be installed in any orientation:

It is important to provide adequate ventilation so that the admissible ambient temperature (max. 50°C) is not exceeded.

Technical data

Supply (bus connector on side)	Operating voltage range	DC 21.5 ... 26 V (SELV / PELV) or DC 24 V class 2 (US)
	Max. power consumption	TXM1.8X 2.2 W TXM1.8X-ML 2.3 W <i>(for the sizing of power supplies, see CM110562)</i>
Protection	All terminals of the modules	Against shortcut and incorrect wiring with AC / DC 24 V
	Bus connector on side	No protection!
Field devices		
Insulation resistance	The of the connected field devices against mains voltage must comply with the requirements for safety extra-low voltage (SELV) or protection by extra-low voltage (PELV) as per HD 384.	
Measuring cables	Cable material	Solid or stranded copper wire
	Cable cross section	See manual CM110562
	Permitted cable length	max. 300 m
DC output (field supply) ( , Terminals 3, 11, 20, 28)	Nominal voltage (derived in the module from the module supply voltage)	DC24 V
	Admissible current per module	Max. 200 mA (total for all 4 terminals)
AC/DC output (field supply) ( , Terminals 7, 15, 24, 32)	Voltage	AC / DC 12 ... 24 V
	Admissible current per module	Max. 4 A (total for all 4 terminals)
	Fuse	T 10A, in power supply module / bus connection module
	 Caution!	Wiring of the AC/DC 24 V supply: Use cable cross section suited for 10 A according to local regulations.
Digital inputs / counter inputs	Digital inputs are not electrically separated from the system electronics. Mechanical contacts must be volt-free. Electronic switches must comply with SELV / PELV standards. <i>Counter inputs faster than 1 Hz that are routed for more than 10 m in the same trunking as analog inputs must be shielded.</i>	
	Contact sensing voltage	DC 21.5 ...25 V
	Contact sensing current	1.0 mA (initial current 6 mA)
	Contact resistance with contacts closed	Max. 200Ω
	Contact resistance with contacts open	Min. 50kΩ

	Min. closing / opening time [ms] including bouncing	Max. bounce time [ms]	Max. Counting frequency (symmetric)
Maintained contact	60	20	
Pulse contact	30	10	
Counter mechanic	20	10	25 Hz
Counter electronic	..5	..0	100 Hz
Counter memory	0 ... 4.3 x 10 ⁹ (32 bit counter)		

Analog inputs

Correction of line resistance	1 Ω (calibrated In module)		
-------------------------------	----------------------------	--	--

Signal type (see page 2)	Range	Under / over range	Resolution
Resistance Pt 1000 and resistance transmitter			
AI Pt1000	0...2500 Ohm	0...2650 Ohm	100 mOhm
AI 2500 Ohm	0...2500 Ohm	0...2650 Ohm	100 mOhm
Temp. measurement			
AI PT1K 375	-50...180	-52.5...185.0 °C	10 mK
AI PT1K 385 ¹⁾	-50...400 (600) °C	¹⁾ -52.5...610°C	20 mK
AI NI1000 extended ¹⁾	-50...150 (180) °C	¹⁾ -52.5...185.0 °C	10 mK
AI NI1000	-50...150°C	-52.5...155.0 °C	10 mK
AI T1 (PTC) ¹⁾	-50...130 (150) °C	¹⁾ -52.5...155.0 °C	10 mK
AI NTC10K ¹⁾	(-40...115 °C)	¹⁾ -52.5...155°C	10 mK (25°C)
AI NTC100K ¹⁾	(-40 ...125 °C)	¹⁾ -52.5...155°C	10 mK (25°C)

¹⁾ 180 °C, 600°C, NTC: only with reduced hum injection

Voltage measurement	AI 0-10V ²⁾	0 ... 10 V	²⁾ -1.5...11.5 V	1 mV
---------------------	------------------------	------------	-----------------------------	------

²⁾ In case of open connection: negative voltage -3.1 V, 0.05 mA (open circuit detection)

Current measurement	AI 4-20mA	4...20 mA	1.6...22.4 mA	1 μA
	AI 0-20mA	0...20 mA	-3.0...23 mA	1 μA

(25 mA see CM10563)

Load resistance

490 / 440 ohms, pulsing (cyclic interrogation of the I/O points)

Note: if the peripheral device can not drive this load, the signal must be connected via a current measuring converter.

Analog outputs

Signal type	Range	Under / over range	Resolution	
Output voltage	AO 0-10V	0 ... 10 V	-0.05...10.6 V	1 mV
Output current		max. 1 mA		
Output current				
I/O points 5 ... 8 only)	AO 4-20mA	4 ... 20 mA	3.92...20.96 mA	1 μA
Output voltage		ca. DC 15 V		
Load resistance		0 ... 500 Ohm		

Connection terminals

Mechanical design
Solid conductors

Rising cage terminals

1 x 0.5 mm² to 4mm²

or 2 x 0,6 mmØ to 1.5 mm²

Stranded conductors without connector sleeves

1 x 0.5 mm² to 2.5 mm²

or 2 x 0,6 mmØ to 1.5 mm²

Stranded conductors with connector sleeves (DIN 46228/1)

1 x 0.25 mm² to 2.5 mm²

or 2 x 0,6 mmØ to 1.5 mm²

Screwdriver

No. 1 Screwdriver for slotted or recessed-head * screws

with shaft diameter ≤ 4.5 mm

* Combined slotted / recessed-

head screws from mid-2012

Max. tightening torque

0.6 Nm

Test pickups (test terminals)

For pin diameter	1.8 ... 2.0 mm
------------------	----------------

Local override (TXM1.8X-ML only)	Local override / indication device	ISO 16 484-2, Section 3.11	
Classification to EN 60730	Mode of operation of automatic electrical controls	Type 1	
	Contamination level	2	
	Mechanical design	Protection class III	
Housing protection standard	Protection standard to EN 65029		
	Front-plate components in DIN cut-out	IP30	
	Terminal base	IP20	
Ambient conditions	Operation	To IEC 60721-3-3	
	Climatic conditions	Class 3K5	
	Temperature	-5 ... 50 °C	
	Humidity	5 ... 95 % rh	
	Mechanical conditions	Class 3M2	
	Transport / storage	To IEC 60721-3-2	
	Climatic conditions	Class 2K3	
	Temperature	-25...70 °C	
	Humidity	5 ... 95 % rh	
	Mechanical conditions	Class 2M2	
Standards, directives and approvals	Product standard	EN 60730-1	Automatic electrical controls for household and similar use
	Electromagnetic compatibility (Applications)		For use in residential, commercial, light-industrial and industrial environments
	EU conformity (CE)		CM1T10870xx *)
	UL certification (US)		UL 916, UL 864, http://ul.com/database
	CSA certification		Class 4812 https://www.csagroup.org/services-industries/product-listing/
	RCM-conformity (EMC)		CM1T10870en_C1 *)
	EAC conformity		Eurasia conformity
Environmental compatibility	Product environmental declaration (contains data on RoHS compliance, materials composition, packaging, environmental benefit, disposal)		CM2E8174 *)
Color	Terminal base and plug-in I/O module	RAL 7035 (light gray)	
Dimensions	Housing to DIN 43 880, see "Dimensions"		
Weight	Without / with packaging	TXM1.8X	194 / 215 g
		TXM1.8X-ML	211 / 232 g

*) The documents can be downloaded from <http://siemens.com/bt/download>.

Connection diagrams (examples)

Digital inputs

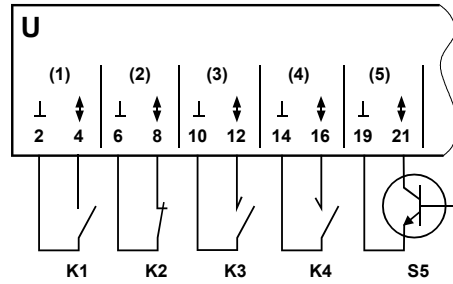

- U** Super universal module
- K1** Status contact (N/O)
- K2** Status contact (N/C)
- K3** Pulse contact (N/O)
- K4** Pulse contact (N/C)
- S5** Electronic switch

8174z13

Terminal layout

I/O point	TXM1.8X, TXM1.8X-ML							
	(1)	(2)	(3)	(4)	(5)	(6)	(7)	(8)
System neutral \perp (-) ¹⁾	2	6	10	14	19	23	27	31
Input \updownarrow (+)	4	8	12	16	21	25	29	33

Counter inputs

Counter inputs faster than 1 Hz that are routed for more than 10 m in the same trunking as analog inputs must be shielded.

Analog inputs

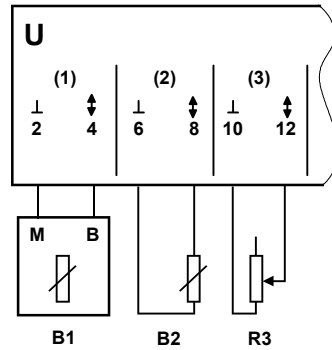

8174z14

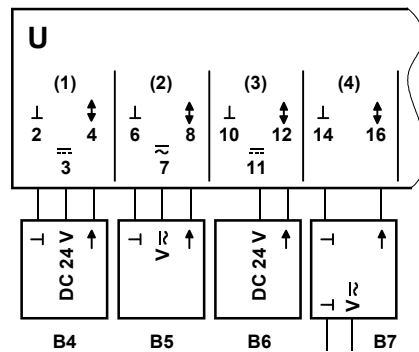

- U** Super universal module
- B1** LG-Ni 1000 temperature sensor
- B2** General temperature sensor
- R3** Resistance transmitter r
- B4** Active sensor with DC 24 V supply
- B5** Active sensor with AC / DC supply
- B6** Active sensor 0 ... 20 mA or 4 ... 20 mA (2-wire)
- B7** Active sensor with external supply
External supply must NOT be earthed (earth loop)

Terminal layout

I/O point	TXM1.8X, TXM1.8X-ML							
	(1)	(2)	(3)	(4)	(5)	(6)	(7)	(8)
Measuring neutral \perp (-) ¹⁾	2	6	10	14	19	23	27	31
Input \updownarrow (+)	4	8	12	16	21	25	29	33
AC/DC sensor supply voltage ²⁾	Selected from: 7, 15, 24, 32							
DC +24 V sensor supply voltage ³⁾	Selected from: 3, 11, 20, 28							

Analog outputs

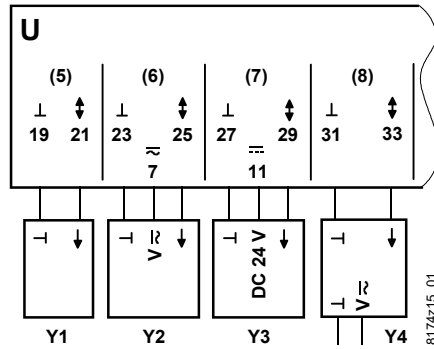

- U** Super universal module
- Y1** Actuator with input
DC 0 ..10 V or 4 ... 20 mA
- Y2 ... Y4** General device with input
DC 0 ..10 V or 4 ... 20 mA,
Supply AC / DC, DC 24 V or
externally
*External supply must NOT be
earthed (earth loop)*

Terminal layout tension

I/O point	TXM1.8X, TXM1.8X-ML							
	(1)	(2)	(3)	(4)	(5)	(6)	(7)	(8)
System neutral ⊥ (-) ¹⁾	2	6	10	14	19	23	27	31
Output ⚡ (+)	4	8	12	16	21	25	29	33
AC/DC operating voltage ²⁾	Selected from: 7, 15, 24, 32 ²⁾							
DC +24 V operating voltage ³⁾	Selected from: 3, 11, 20, 28 ³⁾							

Terminal layout current

I/O point	TXM1.8X, TXM1.8X-ML							
	(1)	(2)	(3)	(4)	(5)	(6)	(7)	(8)
System neutral ⊥ (-) ¹⁾	--	--	--	--	19	23	27	31
Output ⚡ (+)	--	--	--	--	21	25	29	33
AC/DC operating voltage ²⁾	Selected from: 7, 15, 24, 32 ²⁾							
DC +24 V operating voltage ³⁾	Selected from: 3, 11, 20, 28 ³⁾							

¹⁾ All measuring / system neutral terminals are interconnected, not in the terminal base but in the plug-in I/O module. When this unit is pulled outward (into the "parking" position) there is no connection.

- The system neutral of a digital input can be connected to any system neutral terminal
- With analog inputs and outputs, the measuring / system neutral must always be connected to the terminal associated with that I/O point.

²⁾ All **AC/DC** 24V supply terminals are interconnected (in the I/O module, not in the terminal base).

They are protected in the **power supply module / bus connection module** (T10A).
Wiring of the AC 24V/DC V supply (terminals 7, 15, 24, 32):

Use cable cross section suited for 10 A according to local regulations.

³⁾ All **DC 24 V** supply terminals are interconnected.

They are protected in the **module** against shortcut and incorrect wiring.

⚠ Caution!

For wiring details refer to the TX-I/O™ Engineering and installation manual, CM110562.

Dimensions

Dimensions in mm

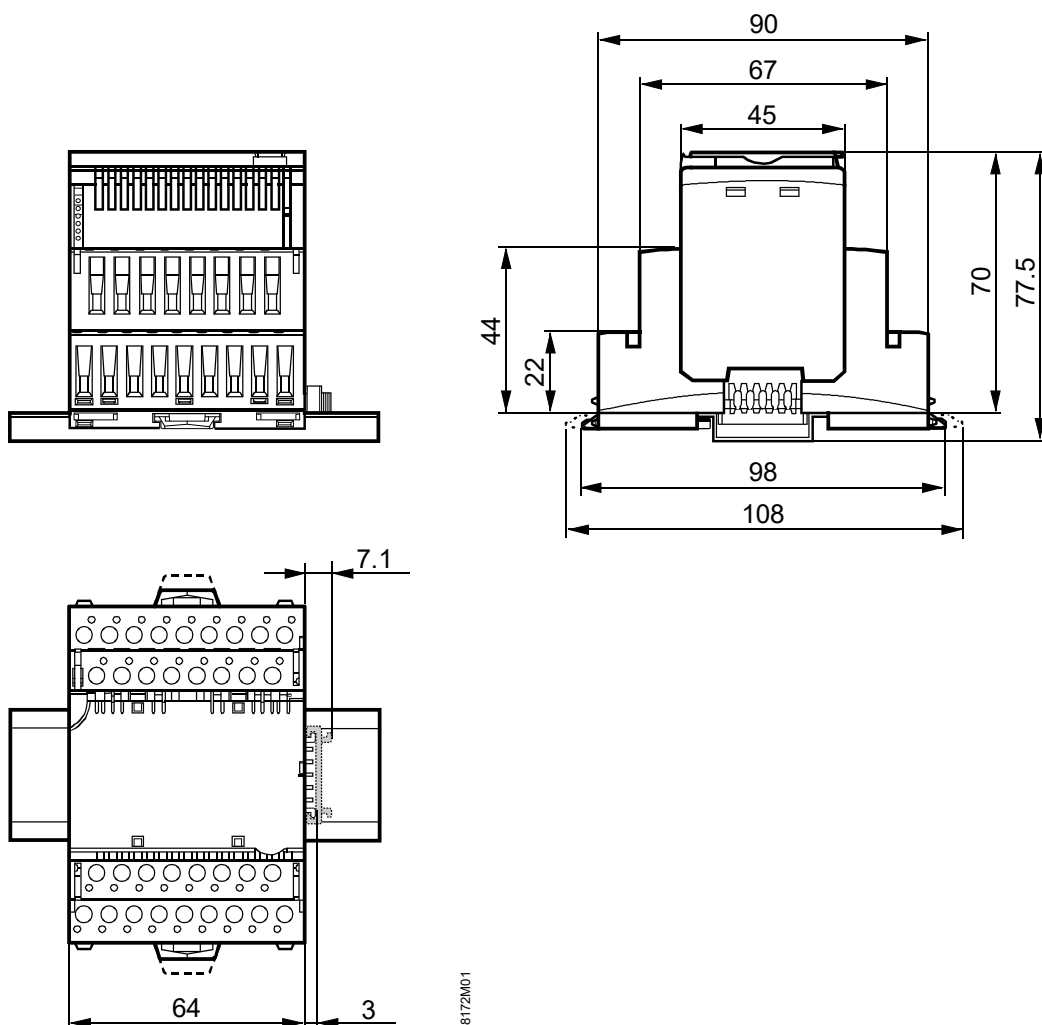

Published by:
 Siemens Switzerland Ltd.
 Building Technologies Division
 International Headquarters
 Gubelstrasse 22
 6301 Zug
 Switzerland
 Tel. +41 41-724 24 24
www.siemens.com/buildingtechnologies

© Siemens Switzerland Ltd 2007
 Delivery and technical specifications subject to change