

# Info card

## Inductive sensors



**i** This info card is to be regarded as a supplement to the main position sensors catalogue and to the individual data sheets. For further information and contact addresses please visit our homepage at [www.ifm.com](http://www.ifm.com).

### Intended use

While in use the products are exposed to influences which may have an effect on function, life, quality and reliability of the product.

It is the customer's responsibility to ensure that the products are suitable for the intended application. This applies in particular to applications in hazardous areas and with adverse environmental influence such as pressure, chemicals, temperature fluctuations, moisture and radiation as well as mechanical stress, especially if the products are not installed properly.

Using the products in applications where the safety of people depends on the function of the product is not permitted. Non-compliance may result in death or serious injuries.

### Operating principle of an inductive proximity switch

Coil and capacitor form an LC resonant circuit, also called basic sensor.

Eddy current losses in electrically-conductive materials are used for a switching signal.

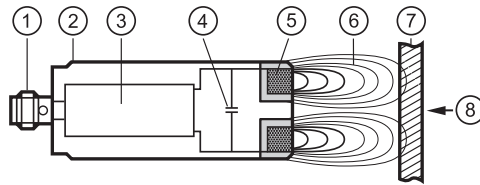

- ① Connection
- ② Housing
- ③ Downstream electronics
- ④ Capacitor
- ⑤ Pot core
- ⑥ Coil
- ⑦ Alternating electromagnetic field = active zone
- ⑧ Target = electrically conductive material

### Important Glossary

Active zone / active face	Area above the sensing face in which the sensor reacts to the approach of the target.
Output function	<p>Normally open: object within the active zone &gt; output is switched.</p> <p>Normally closed: object within the active zone &gt; output is blocked.</p> <p>Programmable: choice between normally closed or normally open.</p> <p>Positive switching: positive output signal (to L-).</p> <p>Negative switching: negative output signal (to L+).</p>
Rated insulation voltage	AC units depending on UB: 140 V AC or 250 V AC DC units with protection class II: 250 V AC DC units with protection class III: 60 V DC
Rated short-circuit current	for short-circuit-proof units: 100 A
Rated impulse withstand voltage	AC units depending on UB: 140 V AC = 2.5 kV or 250 V AC = 4 kV (± overvoltage category III) DC units with protection class II: 4 kV (± overvoltage category III) DC units with protection class III: 60 V DC 0.8 kV (± overvoltage category II)
Power-on delay time	The time the sensor needs to be ready for operation after application of the operating voltage (in the millisecond range).

Operating voltage	The voltage range in which the sensor functions reliably. A stabilised and smoothed direct voltage should be used! Take into account residual ripple!
Utilisation category	AC units: AC-140 (control of small electromagnetic loads with holding currents < 200 mA) DC units: DC-13 (control of solenoids)
Hysteresis	Difference between the switch-on and the switch-off point.
Short-circuit protection	ifm sensors which are protected against excessive current by means of a pulsed short-circuit protection. The inrush current of incandescent lamps, electronic relays and low resistance loads may cause this protection to cut in and turn the sensor off!
Standard target	Square-shaped steel plate (e.g. S235JR) of a thickness of 1 mm with a side length equal to the diameter of the sensing face or 3 x S <sub>N</sub> , depending on which value is the highest.
Product standard	IEC 60947-5-2
Repeatability	Difference between any two S <sub>r</sub> measurements. Max. 10 % of S <sub>r</sub> .
Leakage current	Current for the internal supply of 2-wire units; also flows through the load when the output is blocked.
Switch point drift	The shifting of the switch point owing to changes in the ambient temperature.
Switching frequency	Damping with standard target at half S <sub>N</sub> . The ratio damped to undamped (tooth to gap) = 1 : 2.
Protection rating	IPxy According to IEC 60529 IP68 Test condition: 1 m water depth for 7 days IP69K To ISO 20653 (replacement for DIN 40050-9)
Current consumption	Current for the internal supply of 3-wire DC units.
Degree of soiling	Inductive proximity sensors are designed for degree of soiling 3.

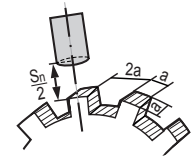

### Sensing range (referred to the standard target)

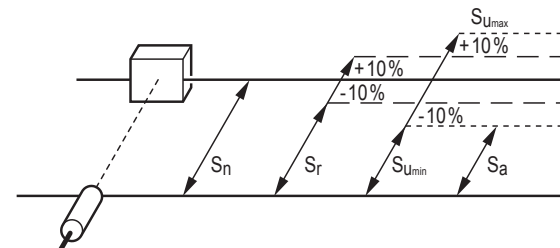

- Nominal sensing range S<sub>N</sub> = characteristic value of the unit
- Real sensing range S<sub>r</sub> = individual deviation at room temperature between 90 % and 110 % of S<sub>N</sub>
- Useful sensing range s<sub>U</sub> = switch point drift between 90 % (S<sub>Umin</sub> = S<sub>A</sub>) and 110 % (S<sub>Umax</sub>) of S<sub>r</sub>
- Reliable sensing range = operating distance S<sub>A</sub> = reliably switched between 0 % and 81 % of S<sub>N</sub>
- Safe switch-off distance = S<sub>Umax</sub> + max. hysteresis = 143 % of S<sub>N</sub>

# Info card

## Inductive sensors



### Correction factors

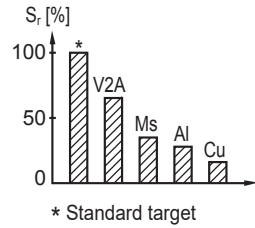

Values → data sheet  
Exception K1 units:  
Same sensing range for all

### Influence of the target size

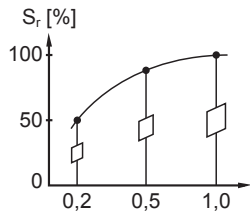

x axis: ratio actual target / standard target

### Lateral approach and ranges (valid for structural steel, e.g. S235JR)

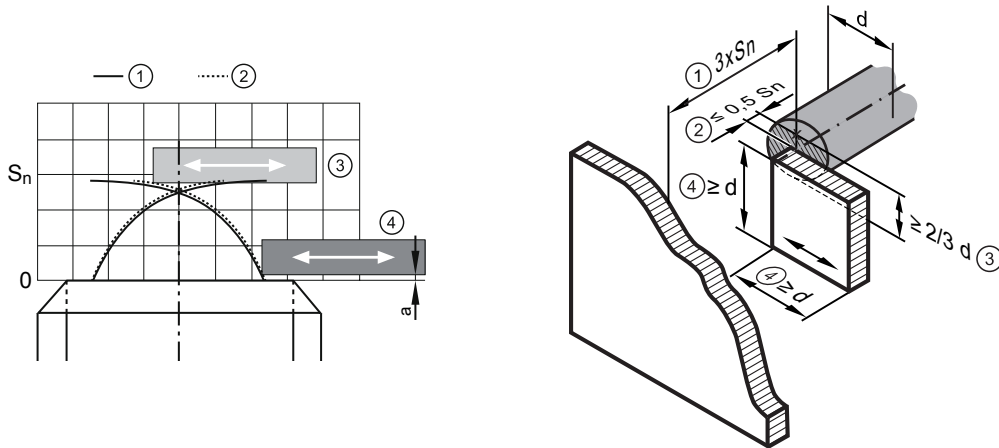

- ① Typical switch-on curve (for slow approach)
- ② Typical switch-off curve (for slow approach)
- ③ Poor repeatability
- ④ Good repeatability

- ① Distance to the background
- ② Recommended target distance
- ③ Recommended degree of coverage of the sensing face
- ④ Recommended target size

Good repeatability of the switch point means: The closer the target is positioned to the sensing face, the better.

General recommendation:  
 $a = 10\%$  of the nominal sensing range

### Tips on flush and non-flush mounting in metal

#### Installation instructions cylindrical designs

Flush:

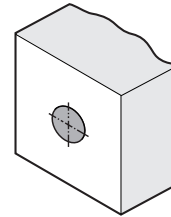

Non-flush:

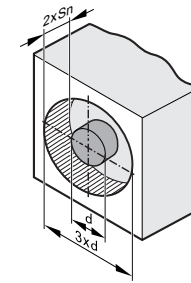

#### Installation instructions rectangular designs

Flush:

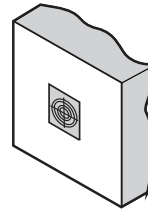

Non-flush:

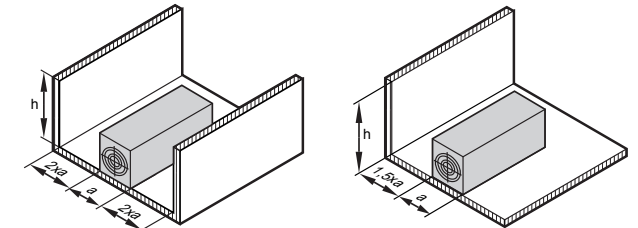

$h = \text{any}$

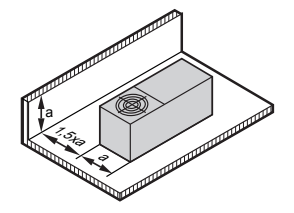
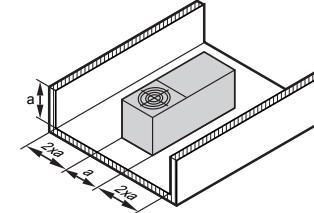
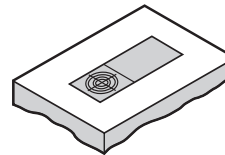

**i** If the required clear space is not observed for non-flush units, the sensor is predamped. This may lead to permanent switching.

**i** Possibly deviating installation instructions for rectangular units with increased sensing range → Notes on mounting and operation.

# Info card

## Inductive sensors



### Minimum clearance for installing units of the same type (side-by-side installation)

Applies to cylindrical and rectangular sensors.

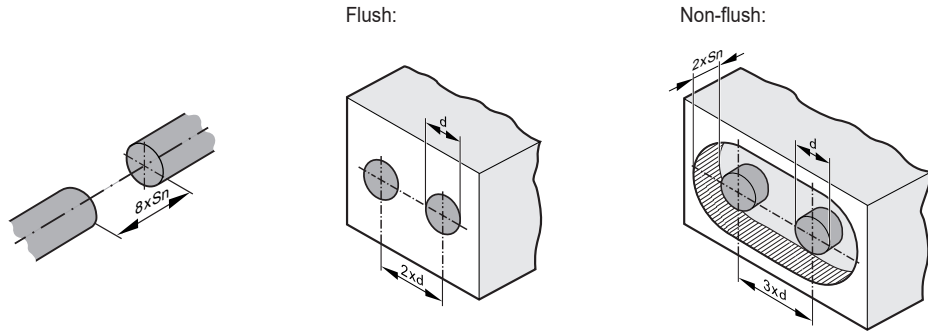

**i** Side-by-side installation only possible with different oscillator frequency.

### Electrical connection

- ① Use a miniature fuse according to the technical data sheet, if specified.  
Recommendation: Check the safe functioning of the unit after a short circuit.
- ② Negative switching
- ③ Positive switching
- ④ Sensor 1
- ⑤ Sensor n

### Connection systems

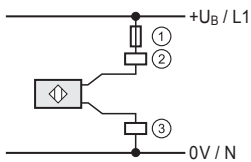

Two-wire technology  
(negative or positive switching)

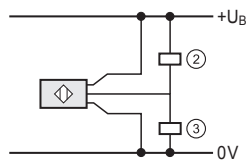

3-wire technology  
(negative or positive switching)

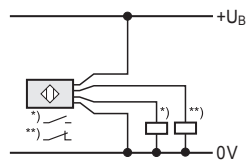

4-wire technology  
(positive switching, normally closed and normally open)

### Series connection (AND)

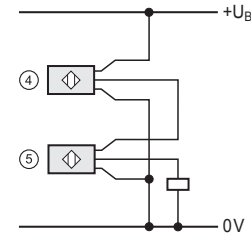

#### Series connection of 3-wire units

Max. 4 units. Power-on delay times, voltage drops and current consumptions add up.  $U_{B \min}$  (sensor) and  $U_{HIGH \min}$  (load) must remain unchanged.

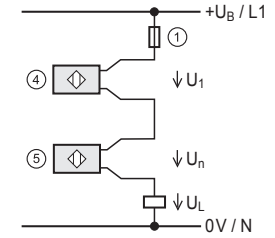

#### Series connection of 2-wire units

Not recommended because of undefined operation when blocked! Use special types which can be connected in series (max. 2 units). Voltage drops add up.

### Parallel connection (OR)

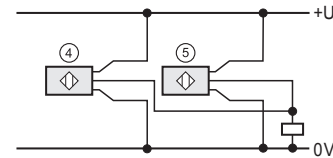

#### Parallel connection 3-wire units

The current consumption of all non-switched units adds up. The units can be used in combination with mechanical switches.

#### Parallel connection 2-wire units

Not possible.

### Configuration of cables and connectors

Colours: BK: black, BN brown, BU: blue, WH: white

Standard configuration for 3-wire DC:

		Cable	Terminal chamber	US-100 plug
L+		BN	1 / 3	Pin 1 / BN
L-		BU	2 / 4	Pin 3 / BU
Output		BK	X	Pin 2 / WH Pin 4 / BK

### Pin connection of the US-100 connections (view onto the plug of the unit)

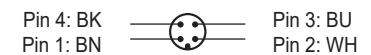

For the cable and the pin configuration as well as the unit data of special versions please refer to the wiring diagrams in our main catalogue for position sensors.

UK