



Main

Range of product	OsiSense XU
Series name	General purpose single mode
Electronic sensor type	Photo-electric sensor
Sensor name	XUK
Sensor design	Compact 50 x 50
Detection system	Diffuse with background suppression
Material	Plastic
Type of output signal	Discrete
Supply circuit type	DC
Wiring technique	3-wire
Discrete output type	PNP or NPN
Discrete output function	1 NO or 1 NC programmable
Electrical connection	1 male connector M12, 4 pins
Product specific application	-
Emission	Infrared laser, modulated diffuse with background suppression (class 1)
[Sn] nominal sensing distance	1 m diffuse with background suppression

Complementary

Enclosure material	PC
Lens material	PMMA
Maximum sensing distance	1 m diffuse with background suppression
Minimum object diameter for detection	2 mm
Output type	Solid state
Wire insulation material	PVC
Status LED	1 LED (green) for supply 1 LED (yellow) for output state
[Us] rated supply voltage	12...24 V DC with reverse polarity protection
Supply voltage limits	10...36 V DC
Switching capacity in mA	<= 100 mA (overload and short-circuit protection)
Switching frequency	<= 250 Hz
Voltage drop	<= 1.5 V (closed state)

Disclaimer: This documentation is not intended as a substitute for and is not to be used for determining suitability or reliability of these products for specific user applications

Current consumption	<= 30 mA (no-load)
Delay first up	< 300 ms
Delay response	< 2 ms
Delay recovery	< 2 ms
Setting-up	Sensitivity adjustment by potentiometer
Depth	50 mm
Height	50 mm
Width	18 mm
Product weight	0.035 kg
Kit composition	With XUZA51 bracket fixing

Environment

Product certifications	CE Ecolab
Ambient air temperature for operation	-20...60 °C
Ambient air temperature for storage	-30...70 °C
Vibration resistance	7 gn, amplitude = +/- 1.5 mm (f = 10...55 Hz) conforming to IEC 60068-2-6
Shock resistance	30 gn (duration = 11 ms) conforming to IEC 60068-2-27
IP degree of protection	IP65 double insulation conforming to IEC 60529

Offer Sustainability

RoHS (date code: YYWW)	Compliant - since 0841 - Schneider Electric declaration of conformity Schneider Electric declaration of conformity
REACH	Reference not containing SVHC above the threshold Reference not containing SVHC above the threshold

Contractual warranty

Warranty period	18 months
-----------------	-----------

Dimensions

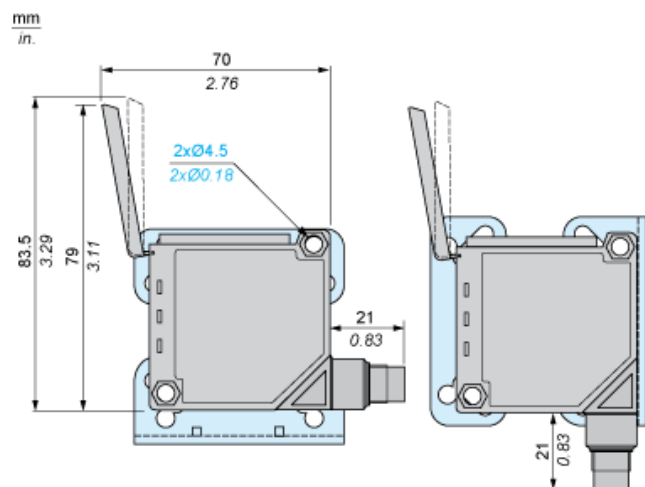

Bracket fixing

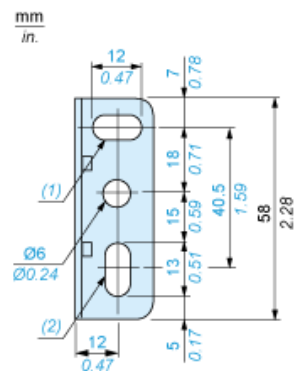

- (1) 1 elongated hole Ø 6 x 12
- (2) 1 elongated hole Ø 6 x 13

Wiring Schemes

Connector

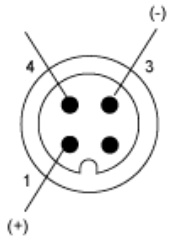

NO/NC programming

PNP Output

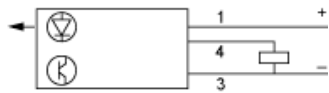

NPN Output

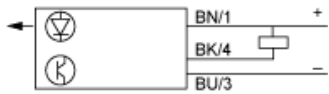

BN : Brown
BU : Blue
BK : Black

Detection Curves

Variation of Usable Sensing Distance S_u

Adjustment at 10 cm

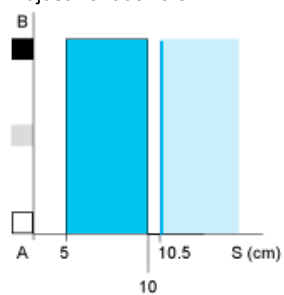

Adjustment at 1 m

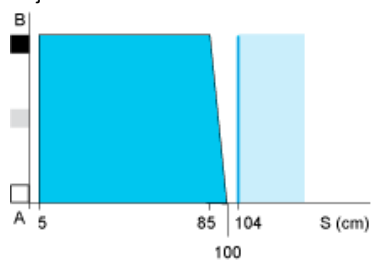

- (1) Black
- (2) Grey
- (3) White
- (4) Sensing range
- (5) Non sensing zone (matt surfaces)

- A-B : Object reflection coefficient
- (1) Black 6%
 - (2) Grey 18%
 - (3) White 90%
 - (4) Sensing range
 - (5) Non sensing zone (matt surfaces)

Sensing Distance Adjustment

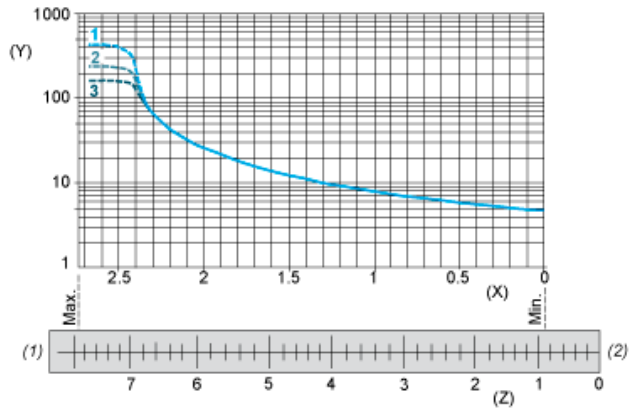

- 1 : White 90%
- 2 : Grey 18%
- 3 : Black 6%
- (Y) Sensing distance (cm)
- (X) Number of turns on potentiometer
- (Z) Setting indicator position (mm)

Relative Difference in Sensing Distances According to Object Colour

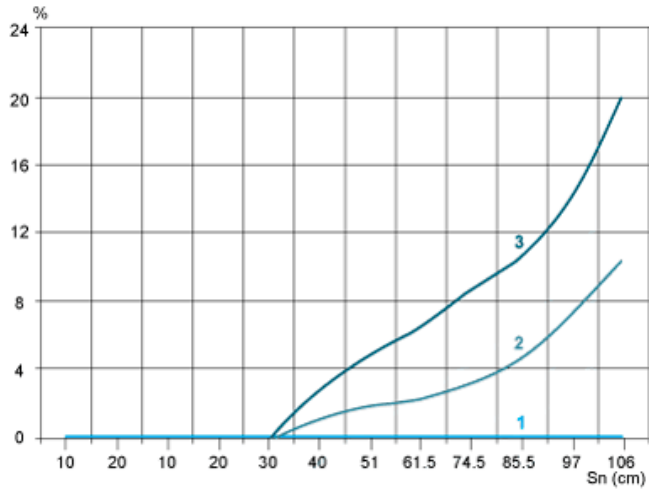

- 1 : White 90%
- 2 : Grey 18%
- 3 : Black 6%